



**2012 Standard Specifications for Construction**

Warranty No FHWA Oversight No  
DBE % Yes NHS No

ITEM NUMBER  
**1412 002**

**STATE OF MICHIGAN DEPARTMENT OF TRANSPORTATION  
PROPOSAL**

**BIDS WILL BE ELECTRONICALLY DOWNLOADED AT 10:30 AM LOCAL TIME, ON 12/5/14**

<u>CONTRACT ID</u>	<u>CONTROL SECTION</u>	<u>PROJECT</u>	<u>FEDERAL NO.</u>	<u>FED. ITEM</u>
03609-119603	STH 03609	119603A	HSIP 1503(003)	KK3676

The bidder has downloaded and examined the plans, specifications, special provisions, and related materials in the proposal, as well as the location of the work described in the proposal for this project, and has obtained all addenda issued for this project, and is fully informed as to the nature of the work and the conditions relating to its performance and understands that the quantities shown are approximate only and are subject to either increase or decrease.

The bidder hereby proposes to furnish all necessary machinery, tools, apparatus, and other means of construction, do all the work, furnish all the materials except as otherwise specified and, for each unit price, lump sum, or one each named in the itemized bid, to complete the work in strict conformity with the plans therefore and the entire proposal which is incorporated by reference in these pages, and in strict conformity with the requirements of the 2012 Standard Specifications for Construction, Michigan Department of Transportation and such other special provisions and supplemental specifications as may be a part of the proposal for this project.

The bidder further proposes to do such extra work as may be authorized by the Department, prices for which are not included in the itemized bid. Compensation shall be made on the basis agreed upon before such extra work is begun.

The bidder hereby certifies that if it is not prequalified in all classifications required by the advertisement for this project, it has taken such preparatory steps as may be necessary and will within the time specified in Subsection 102.15 of the 2012 Standard Specifications for Construction, designate subcontractor(s) that are fully prequalified in the classification(s) to perform the work.

THE BIDDER UNDERSTANDS AND AGREES THAT THE DEPARTMENT RESERVES THE RIGHT TO REJECT ANY AND ALL BIDS AND NO CONTRACTUAL RELATIONSHIP SHALL EXIST BETWEEN THE BIDDER AND THE DEPARTMENT FOR THE WORK DESCRIBED HEREIN UNTIL SUCH TIME AS THE CONTRACT HAS BEEN FORMALLY EXECUTED BY BOTH THE BIDDER AND THE DEPARTMENT.

The bidder agrees upon submitting this bid that its agents, officers or employees have not directly or indirectly entered into any agreements, participated in any collusion, or otherwise taken any action in restraint of free competitive bidding in connection with this proposal for the above project.

Unless the bidder gives MDOT advance written notice, MDOT may correspond directly with the insurance agencies concerning questions and problems with the insurance certificates, bonds and related materials. It is the obligation of the bidder to monitor the filing of the insurance certificates, bond, and related materials with MDOT and the bidder is responsible for any failure to provide MDOT with the required materials, on a timely basis and in proper form.

Subject to Subsection 102.17 of the 2012 Standard Specifications for Construction, the bidder agrees to pay to the Michigan Department of Transportation the bid guaranty sum of **\$10,000.00** if the bidder fails to provide the required materials and/or execute the contract in accordance with Subsection 102.15 of the 2012 Standard Specifications for Construction.

**Kalamazoo TSC**

# **BIDDER INFORMATION FOR CONSTRUCTION BIDDING**

Electronic Bid – The electronic bid consists of the following section folders: Schedule of Items, Designated and Specialty Items, DBE Goal (if applicable), Warranty Obligations, Addenda Acknowledgment and Instructions.

The Instructions folder provides an explanation for each section of the electronic bid including the agreement for the bid guaranty sum. The bid guaranty is NOT required at the time of bidding, or with submitting an electronic bid.

*Subject to Subsection 102.17, of the 2012 Standard Specifications for Construction, the Bidder agrees to pay to the Michigan the bid guaranty sum if the Bidder fails to provide the required materials and/or execute the contract in accordance with the 2012 Standard Specifications for Construction within twenty-eight (28) days after being sent the necessary award documents.*

All written and electronic addendums issued for project(s) the Bidder elects to bid, must be obtained prior to submitting the electronic bid.

Electronic bids must be submitted by the 10:30 a.m. deadline on the scheduled letting date.

**NOTE:** Any financial or propriety information submitted with the electronic bid will become a public record subject to disclosure under the Freedom of Information Act. THE INFORMATION WILL NOT BE TREATED AS CONFIDENTIAL.

The apparent low Bidder is determined following a review for any discrepancies in the bid and where all requirements of the bid and apparent low Bidder are met.

***THE RIGHT IS RESERVED TO REJECT ANY OR ALL BIDS***

*Revised 9/15/2011*



Proposal Price Schedule - Schedule of Items

Report v1

Proposal ID: 03609-119603

Project(s): 119603A

Letting Number: 141205

Call Number: 002

Contractor: \_\_\_\_\_

Section Information

Section ID	Section Description	Section Total	Alt. Set ID	Alt. Member ID
1	Federal 90%/Allegan CRC 10%			

Item Prices

Proposal Line Number	Item ID - Description	Approximate Quantity and Units	Unit Price	Bid Amount
0010	1500001 Mobilization, Max. ____ \$39300.00	1.000 LSUM		
0020	2010001 Clearing	5.000 Acre		
0030	2030001 Culv, Rem, Less than 24 inch	1.000 Ea		
0040	2040045 Masonry and Conc Structure, Rem	5.000 Cyd		
0050	2050001 Backfill, Swamp	5,000.000 Cyd		
0060	2050010 Embankment, CIP	20,100.000 Cyd		
0070	2050016 Excavation, Earth	24,300.000 Cyd		
0080	2050017 Excavation, Peat	5,000.000 Cyd		
0090	2050041 Subgrade Undercutting, Type II	1,000.000 Cyd		
0100	2080012 Erosion Control, Check Dam, Stone	50.000 Ft		
0110	2080036 Erosion Control, Silt Fence	400.000 Ft		
0120	2090001 Project Cleanup	1.000 LSUM		
0130	3010002 Subbase, CIP	5,100.000 Cyd		



Proposal Price Schedule - Schedule of Items

Report v1

Item Prices

Proposal Line Number	Item ID - Description	Approximate Quantity and Units	Unit Price	Bid Amount
0140	3060010 Aggregate Surface Cse, 6 inch	10,060.000 Syd		
0150	3070021 Approach, CI II	126.000 Ton		
0160	3080005 Geotextile, Separator	200.000 Syd		
0170	3080010 Geotextile, Stabilization	200.000 Syd		
0180	4010024 Culv End Sect, 24 inch	2.000 Ea		
0190	4010542 Culv, CI E, 24 inch	136.000 Ft		
0200	4010797 Culv, Downspout, 18 inch	200.000 Ft		
0210	4021275 Video Taping Sewer and Culv Pipe	338.000 Ft		
0220	4040063 Underdrain, Subbase, 6 inch	800.000 Ft		
0230	4040093 Underdrain Outlet, 6 inch	40.000 Ft		
0240	4040113 Underdrain, Outlet Ending, 6 inch	4.000 Ea		
0250	5010025 Hand Patching	50.000 Ton		
0260	8070000 Guardrail, Type B	1,188.000 Ft		
0270	8070010 Guardrail, Curved, Type B	63.000 Ft		
0280	8070042 Guardrail Approach Terminal, Type 2B	4.000 Ea		
0290	8070080 Guardrail Reflector	45.000 Ea		
0300	8070095 Post, Mailbox	2.000 Ea		
0310	8120010 Barricade, Type III, High Intensity,	14.000 Ea		



Proposal Price Schedule - Schedule of Items

Report v1

Item Prices

Proposal Line Number	Item ID - Description	Approximate Quantity and Units	Unit Price	Bid Amount
0320	Double Sided, Furn 8120011 Barricade, Type III, High Intensity, Double Sided, Oper	14.000 Ea		
0330	8120170 Minor Traf Devices	1.000 LSUM		
0340	8120350 Sign, Type B, Temp, Prismatic, Furn	800.000 Sft		
0350	8120351 Sign, Type B, Temp, Prismatic, Oper	800.000 Sft		
0360	8120370 Traffic Regulator Control	1.000 LSUM		
0370	8130005 Riprap, Heavy	150.000 Syd		
0380	8130010 Riprap, Plain	125.000 Syd		
0390	8160100 Slope Restoration, Type A	250.000 Syd		
0400	8160101 Slope Restoration, Type B	2,900.000 Syd		
0410	8160102 Slope Restoration, Type C	12,000.000 Syd		
0420	8240007 Contractor Staking, Road Only	1.000 LSUM		
0430	8240020 Staking Plan Errors and Extras, One Person	3.000 Hr		
0440	8240021 Staking Plan Errors and Extras, Two Person	3.000 Hr		
0450	8240022 Staking Plan Errors and Extras, Three Person	1.000 Hr		

Section 1 Total:  
Total Bid:



Table of Contents 03609-119603

1	Cover Page
2	Bidder Information Page
3	Schedule of Items
7	Table of Contents
9	Type of Work and Project Location
10	Advertising Notice
11	Requirements for DBE
17	Ad Board Requirements
20	Insurance Provisions
21	Progress Clause
22	Maintaining Traffic incl. Details
25	M0020a
27	M0040a
29	M0050a
31	M0110a
33	M0140a
35	WZD-100-A
46	WZD-125-E
49	Unique Special Provisions
49	12MT107-A265 INSURANCE
50	501 HMA Application Estimate
51	816 Slope Restoration, Non-Freeway
54	Special Provisions for this Project
54	12SP102(A) CONTRACTOR PERFORMANCE EVALUATIONS
56	12SP102(C) ELECTRONIC TRANSMITTAL OF CONTRACT DOCUMENTS
57	12SP102(D) LOW BID WITHDRAWAL PRIOR TO CONTRACT AWARD
58	12SP-102G-01 JOINT/TWO PARTY CHECKS
59	12SP-102H-01 DISSEMINATION OF PUBLIC RELATIONS INFORMATION
60	12SP104(A) DEBRIS OR MATERIAL IN TRAFFIC LANES
61	12SP-104B-02 HIGH VISIBILITY CLOTHING
62	12SP104(C) VALUE ENGINEERING CHANGE PROPOSAL (VECP)
66	12SP105(A) SOURCE OF STEEL AND IRON (BUY AMERICA)
69	12SP-107B-02 NPDES INSPECTION AND RESPONSE
70	12SP107(E) CONSTRUCTION STAGING AREAS
71	12SP107(F) E-VERIFY
72	12SP-107G-01 LABOR COMPLIANCE
74	12SP108(C) ON-THE-JOB TRAINING PROGRAM
75	12SP109(A) PROMPT PAYMENT
79	12SP-208A-02 NON-COMPLIANCE WITH SOIL EROSION AND SEDIMENTATION CONTROL REQUIREMENTS
81	12SP208(B) SEDIMENT FILTER FENCE
82	12SP501(A) SAMPLING ASPHALT BINDER ON LOCAL AGENCY PROJECTS
83	12SP501(E) RECYCLED HOT MIX ASPHALT MIXTURE OF LOCAL AGENCY PROJECTS
85	12SP501(F) MARSHALL HOT MIX ASPHALT MIXTURE
87	12SP501(J) ACCEPTANCE OF HMA ON LOCAL AGENCY PROJECTS
89	12SP812(C) TRAFFIC CONTROL QUALITY AND COMPLIANCE
91	12SP812(F) PAYMENT FOR MINOR TRAFFIC DEVICES AND TRAFFIC REGULATOR CONTROL
92	12SP812(L) SUPPORTS FOR TEMPORARY SIGNS
93	12SP812(N) MEASUREMENT AND PAYMENT OF TEMPORARY TRAFFIC CONTROL DEVICES
94	12SP-900A-01 INDUSTRIAL BY-PRODUCTS AND BENEFICIAL RE-USE
95	12SP902(A) GRANULAR MATERIALS
96	12SP902(C) CRUSHED CONCRETE NEAR WATER
97	12SP902(D) ALTERNATIVE GRANULAR MATERIALS FOR FILL AND SUBBASE
98	12SP912(A) MICRONIZED COPPER WATER BASED WOOD PRESERVATIVE SYSTEMS
99	Notice to Bidders for this Project
99	12NB-13-02 MULTIPL DAVIS-BACON WAGE DECISIONS
100	12NB15 BID RIGGING
101	12NB17 NOTICE TO CONTRACTORS/CONSULTANTS FRAUD AND ABUSE HOTLINE
102	12NB18 ROAD CONSTRUCTION APPRENTICESHIP READINESS (RCAR) Program
104	12NB60 BUY AMERICA
105	Utility Coordination
106	Supplemental Specifications
132	Notice of Bidders - Contact Person

133	Attachments
146	Labor Rates
177	Federal-Aid Construction Contracts



<b><u>CONTROL SECTION</u></b>	<b><u>PROJECT</u></b>	<b><u>FEDERAL NO.</u></b>	<b><u>FEDERAL</u></b>
HSIP 03609	119603A	HSIP 1503(003)	<b><u>ITEM NO.</u></b>
			KK 3676

**TYPE OF WORK:**

JN 119603A: Hot mix asphalt patching, clearing, embankment, aggregate surface course, drainage, guardrail and riprap.

**LOCATION:**

JN 119603A: 16th Street at 120th Avenue, Allegan County.

**OWNER:**

Allegan County Road Commission

**MDOT Oversight**



Notice of Advertisement

Letting of: 141205

10:30 A.M., Local Time      425 W. OTTAWA ST., LANSING, MI 48933

Call Num	Contract ID	Control Section	Project Num	Federal Project Num	Federal Item
002	03609-119603	STH 03609	119603A	HSIP 1503(003)	KK3676

Description: Hot mix asphalt patching, clearing, embankment, aggregate surface course, drainage, guardrail, and riprap on 16th Street at 120th Avenue, Allegan County.

Required DBE Participation: 3.00%

Net Classification Required for this project: \*\*415 Ea\*\*

Estimated Pages for Plans: 15

Completion Date: 7/24/2015

See proposal for bidder guaranty information.

Proposal and plans, if applicable, are available for examination online at  
<<http://mdotcf.state.mi.us/public/eprop/login/index.cfm>>

## GENERAL REQUIREMENTS FOR RECIPIENTS

Excerpts from USDOT Regulation 49 CFR, Part 26

### A. **26.5 What Do The Terms Used In This Part Mean? \*(Replaces 23.5 and 23.62)**

Insert the following portions:

*Disadvantaged Business Enterprise or DBE* means a for-profit small business concern—

(1) That is at least 51 percent owned by one or more individuals who are both socially and economically disadvantaged or, in the case of a corporation, in which 51 percent of the stock is owned by one or more such individuals; and

(2) Whose management and daily business operations are controlled by one or more of the socially and economically disadvantaged individuals who own it.

*Small Business Concern* means, with respect to firms seeking to participate as DBEs in DOT-assisted contracts, a small business concern as defined pursuant to section 3 of the Small Business Act and Small Business Administration regulations implementing it (13 CFR part 121) that also does not exceed the cap on average annual gross receipts specified in Sec. 26.65(b).

*Socially and economically disadvantaged individual* means any individual who is a citizen (or lawfully admitted permanent resident) of the United States and who is—

(1) Any individual who a recipient finds to be a socially and economically disadvantaged individual on a case-by-case basis.

(2) Any individual in the following groups, members of which are rebuttably presumed to be socially and economically disadvantaged:

(i) “Black Americans,” which includes persons having origins in any of the Black racial groups of Africa;

(ii) “Hispanic Americans,” which includes persons of Mexican, Puerto Rican, Cuban, Dominican, Central or South American, or other Spanish or Portuguese culture or origin, regardless of race;

(iii) “Native Americans,” which includes persons who are American Indians, Eskimos, Aleuts, or Native Hawaiians;

(iv) “Asian-Pacific Americans,” which includes persons whose origins are from Japan, China, Taiwan, Korea, Burma (Myanmar), Vietnam, Laos, Cambodia (Kampuchea), Thailand, Malaysia, Indonesia, the Philippines, Brunei, Samoa, Guam, the U.S. Trust Territories of the Pacific Islands, Macao, Fiji, Tonga, Kirbati, Juvalu, Nauru, Federated States of Micronesia, or Hong Kong;

(v) “Subcontinent Asian Americans,” which includes persons whose origins are from India, Pakistan, Bangladesh, Bhutan, the Maldives Islands, Nepal or Sri Lanka;

(vi) Women;

(vii) Any additional groups whose members are designated as socially and economically disadvantaged by the SBA, at such time as the SBA designation becomes effective.

*Tribally-owned concern* means any concern at least 51 percent owned by an Indian tribe as defined in this section.

*You* refers to a recipient, unless a statement in the text of this part or the context requires otherwise (i.e., ‘You must do XYZ’ means that recipients must do XYZ).

### B. **26.1 What are the Objectives of this Part? \*(Replaces 23.43)**

This part seeks to achieve several objectives:

(a) To ensure nondiscrimination in the award and administration of DOT-assisted contracts in the Department’s highway, transit, and airport financial assistance programs;

(b) To create a level playing field on which DBEs can compete fairly for DOT-assisted contracts;

(c) To ensure that the Department's DBE program is narrowly tailored in accordance with applicable law;

- (d) To ensure that only firms that fully meet this part's eligibility standards are permitted to participate as DBEs;
- (e) To help remove barriers to the participation of DBEs in DOT- assisted contracts;
- (f) To assist the development of firms that can compete successfully in the marketplace outside the DBE program; and
- (g) To provide appropriate flexibility to recipients of Federal financial assistance in establishing and providing opportunities for DBEs.

**26.3 To Whom Does this Part Apply? *\*(Replaces 23.43)***

- (a) If you are a recipient of any of the following types of funds, this part applies to you:
  - (1) Federal-aid highway funds authorized under Titles I (other than Part B) and V of the Intermodal Surface Transportation Efficiency Act of 1991 (ISTEA), Pub. L. 102-240, 105 Stat. 1914, or Titles I, III, and V of the Transportation Equity Act for the 21<sup>st</sup> Century (TEA-21), Pub. L. 105-178, 112 Stat. 107.
  - (2) Federal transit funds authorized by Titles I, III, V and VI of ISTEA, Pub. L. 102-240 or by Federal transit laws in Title 49, U.S. Code, or Titles I, III, and V of the TEA-21, Pub. L. 105-178.
  - (3) Airport funds authorized by 49 U.S.C. 47101, et seq.
- (b) [Reserved]
- (c) If you are letting a contract, and that contract is to be performed entirely outside the United States, its territories and possessions, Puerto Rico, Guam, or the Northern Marianas Islands, this part does not apply to the contract.
- (d) If you are letting a contract in which DOT financial assistance does not participate, this part does not apply to the contract.

**26.13 What Assurances Must Recipients and Contractors Make? *\*(Replaces 23.43)***

- (a) Each financial assistance agreement you sign with a DOT operating administration (or a primary recipient) must include the following assurance:

The recipient shall not discriminate on the basis of race, color, national origin, or sex in the award and performance of any DOT-assisted contract or in the administration of its DBE program or the requirements of 49 CFR part 26. The recipient shall take all necessary and reasonable steps under 49 CFR part 26 to ensure nondiscrimination in the award and administration of DOT-assisted contracts. The recipient's DBE program, as required by 49 CFR part 26 and as approved by DOT, is incorporated by reference in this agreement. Implementation of this program is a legal obligation and failure to carry out its terms shall be treated as a violation of this agreement. Upon notification to the recipient of its failure to carry out its approved program, the Department may impose sanctions as provided for under part 26 and may, in appropriate cases, refer the matter for enforcement under 18 U.S.C. 1001 and/or the Program Fraud Civil Remedies Act of 1986 (31 U.S.C. 3801 et seq.).

- (b) Each contract you sign with a contractor (and each subcontract the prime contractor signs with a subcontractor) must include the following assurance:

The contractor, sub recipient or subcontractor shall not discriminate on the basis of race, color, national origin, or sex in the performance of this contract. The contractor shall carry out applicable requirements of 49 CFR part 26 in the award and administration of DOT- assisted contracts. Failure by the contractor to carry out these requirements is a material breach of this contract, which may result in the termination of this contract or such other remedy as the recipient deems appropriate.

**C. 26.55 How is DBE Participation Counted Toward Goals? *\*(Replaces 23.47)***

- (a) When a DBE participates in a contract, you count only the value of the work actually performed by the DBE toward DBE goals.

(1) Count the entire amount of that portion of a construction contract (or other contract not covered by paragraph (a)(2) of this section) that is performed by the DBE's own forces. Include the cost of supplies and materials obtained by the DBE for the work of the contract, including supplies purchased or equipment leased by the DBE (except supplies and equipment the DBE subcontractor purchases or leases from the prime contractor or its affiliate).

(2) Count the entire amount of fees or commissions charged by a DBE firm for providing a bona fide service, such as professional, technical, consultant, or managerial services, or for providing bonds or insurance specifically required for the performance of a DOT-assisted contract, toward DBE goals, provided you determine the fee to be reasonable and not excessive as compared with fees customarily allowed for similar services.

(3) When a DBE subcontracts part of the work of its contract to another firm, the value of the subcontracted work may be counted toward DBE goals only if the DBE's subcontractor is itself a DBE. Work that a DBE subcontracts to a non-DBE firm does not count toward DBE goals.

(b) When a DBE performs as a participant in a joint venture, count a portion of the total dollar value of the contract equal to the distinct, clearly defined portion of the work of the contract that the DBE performs with its own forces toward DBE goals.

(c) Count expenditures to a DBE contractor toward DBE goals only if the DBE is performing a commercially useful function on that contract.

(1) A DBE performs a commercially useful function when it is responsible for execution of the work of the contract and is carrying out its responsibilities by actually performing, managing, and supervising the work involved. To perform a commercially useful function, the DBE must also be responsible, with respect to materials and supplies used on the contract, for negotiating price, determining quality and quantity, ordering the material, and installing (where applicable) and paying for the material itself. To determine whether a DBE is performing a commercially useful function, you must evaluate the amount of work subcontracted, industry practices, whether the amount the firm is to be paid under the contract is commensurate with the work it is actually performing and the DBE credit claimed for its performance of the work, and other relevant factors.

(2) A DBE does not perform a commercially useful function if its role is limited to that of an extra participant in a transaction, contract, or project through which funds are passed in order to obtain the appearance of DBE participation. In determining whether a DBE is such an extra participant, you must examine similar transactions, particularly those in which DBEs do not participate.

(3) If a DBE does not perform or exercise responsibility for at least 30 percent of the total cost of its contract with its own work force, or the DBE subcontracts a greater portion of the work of a contract than would be expected on the basis of normal industry practice for the type of work involved, you must presume that it is not performing a commercially useful function.

(4) When a DBE is presumed not to be performing a commercially useful function as provided in paragraph (c)(3) of this section, the DBE may present evidence to rebut this presumption. You may determine that the firm is performing a commercially useful function given the type of work involved and normal industry practices.

(5) Your decisions on commercially useful function matters are subject to review by the concerned operating administration, but are not administratively appealable to DOT.

(d) Use the following factors in determining whether a DBE trucking company is performing a commercially useful function:

(1) The DBE must be responsible for the management and supervision of the entire trucking operation for which it is responsible on a particular contract, and there cannot be a contrived arrangement for the purpose of meeting DBE goals.

(2) The DBE must itself own and operate at least one fully licensed, insured, and operational truck used on the contract.

(3) The DBE receives credit for the total value of the transportation services it provides on the contract using trucks it owns, insures, and operates using drivers it employs.

(4) The DBE may lease trucks from another DBE firm, including an owner-operator who is certified as a DBE. The DBE who leases trucks from another DBE receives credit for the total value of the transportation services the lessee DBE provides on the contract.

(5) The DBE may also lease trucks from a non-DBE firm, including from an owner-operator. The DBE who leases trucks from a non-DBE is entitled to credit only for the fee or commission it receives as a result of the lease arrangement. The DBE does not receive credit for the total value of the transportation services provided by the lessee, since these services are not provided by a DBE.

(6) For purposes of this paragraph (d), a lease must indicate that the DBE has exclusive use of and control over the truck. This does not preclude the leased truck from working for others during the term of the lease with the consent of the DBE, so long as the lease gives the DBE absolute priority for use of the leased truck. Leased trucks must display the name and identification number of the DBE.

(e) Count expenditures with DBEs for materials or supplies toward DBE goals as provided in the following:

(1)(i) If the materials or supplies are obtained from a DBE manufacturer, count 100 percent of the cost of the materials or supplies toward DBE goals.

(ii) For purposes of this paragraph (e)(1), a manufacturer is a firm that operates or maintains a factory or establishment that produces, on the premises, the materials, supplies, articles, or equipment required under the contract and of the general character described by the specifications.

(2)(i) If the materials or supplies are purchased from a DBE regular dealer, count 60 percent of the cost of the materials or supplies toward DBE goals.

(ii) For purposes of this section, a regular dealer is a firm that owns, operates, or maintains a store, warehouse, or other establishment in which the materials, supplies, articles or equipment of the general character described by the specifications and required under the contract are bought, kept in stock, and regularly sold or leased to the public in the usual course of business.

(A) To be a regular dealer, the firm must be an established, regular business that engages, as its principal business and under its own name, in the purchase and sale or lease of the products in question.

(B) A person may be a regular dealer in such bulk items as petroleum products, steel, cement, gravel, stone, or asphalt without owning, operating, or maintaining a place of business as provided in this paragraph (e)(2)(ii) if the person both owns and operates distribution equipment for the products. Any supplementing of regular dealers' own distribution equipment shall be by a long-term lease agreement and not on an ad hoc or contract-by-contract basis.

(C) Packers, brokers, manufacturers' representatives, or other persons who arrange or expedite transactions are not regular dealers within the meaning of this paragraph (e)(2).

(3) With respect to materials or supplies purchased from a DBE which is neither a manufacturer nor a regular dealer, count the entire amount of fees or commissions charged for assistance in the procurement of the materials and supplies, or fees or transportation charges for the delivery of materials or supplies required on a job site, toward DBE goals, provided you determine the fees to be reasonable and not excessive as compared with fees customarily allowed for similar services. Do not count any portion of the cost of the materials and supplies themselves toward DBE goals, however.

(f) If a firm is not currently certified as a DBE in accordance with the standards of subpart D of this part at the time of the execution of the contract, do not count the firm's participation toward any DBE goals, except as provided for in Sec. 26.87(i).

(g) Do not count the dollar value of work performed under a contract with a firm after it has ceased to be certified toward your overall goal.

(h) Do not count the participation of a DBE subcontractor toward the prime contractor's DBE achievements or your overall goal until the amount being counted toward the goal has been paid to the DBE.

Michigan Department  
Of Transportation  
2124A (05/12)

# PRIME CONTRACTOR BI-WEEKLY STATEMENT OF SUBCONTRACTOR/SUPPLIER PAYMENTS

*Portions of the information required in accordance with 49 CFR part 26.37 (as detailed in the prompt payment provisions to monitor the progress of the prime contractor in meeting contractual DBE obligations.)*

**SEE INSTRUCTIONS ON REVERSE**

PRIME CONTRACTOR	CONTRACT ID
------------------	-------------

BI-WEEKLY PERIOD ENDING: \_\_\_\_\_  PROJECT COMPLETION

SUBCONTRACTOR, DBE SUBCONTRACTOR, DBE TRUCKER, DBE SUPPLIER OR SERVICE PROVIDER	SERVICES/WORK CLASSIFICATION	TOTAL SUB CONTRACT AMOUNT	CUMULATIVE DOLLAR VALUE OF SERVICES COMPLETED	DEDUCTIONS	ACTUAL AMOUNT PAID TO DATE	DBE AUTHORIZED SIGNATURE AT PROJECT COMPLETION ONLY	DATE

*As the authorized representative of the above prime contractor, I certify that all payments to non-DBE truckers, and non-DBE suppliers that have performed work or supplied materials to the prime during the reporting period have been made, and I state that to the best of my knowledge, this information is true and accurate.*

CONTRACTORS AUTHORIZED REPRESENTATIVE (Signature)	TITLE	DATE
---	-------	------

**FOR THE MICHIGAN DEPARTMENT OF TRANSPORTATION USE ONLY**

COMMENTS

---

RESIDENT/PROJECT ENGINEER (Signature)	DATE
---------------------------------------	------



# INSTRUCTIONS

## PRIME CONTRACTOR or AUTHORIZED REPRESENTATIVE

This statement reports the actual dollar amounts of the project cost earned by and paid to all subcontractors, DBE subcontractors, DBE suppliers, and DBE truckers. Complete and submit to the Resident/Project Engineer on a bi-weekly basis during the course of the project using the MERS database. This submittal is required prior to release of the second and subsequent estimates per FUSP 109(A). A hard copy of this form must also be submitted 30 days after project completion with actual DBE signatures (not using MERS).

For “*Control Section*” and “*Job No.*” Use the numbers assigned by MDOT.

For “*Services/Work Classification*,” report services/work performed by DBE subcontractors, DBE suppliers, DBE truckers, and DBE consultants listed by work classification code. If they are performing work in more than one classification, report the code with the largest dollar value. A list of work classification codes is available at [www.michigan.gov/mucp](http://www.michigan.gov/mucp).

For “*Total Subcontract Amount*”, report total amount of the contract between the prime contractor and the subcontractor.

For “*Deductions*”, report deductions made by the prime contractor to the subcontractor’s “*Cumulative Dollar Value of Services Completed*” for bond or other fees, materials, services or equipment provided to the subcontractor according to mutual, prior agreement (documentation of such agreement may be required by MDOT).

For “*Actual Amount Paid to Date*”, report cumulative actual payments made to the subcontractor for services completed.

Provide “*DBE Authorized Signature*” on the project completion report.

Be sure to sign, title and date the project completion report.

## MDOT RESIDENT/PROJECT ENGINEER:

Please complete the “*Comments*” area, date and submit within the MERS database within 7 days of receipt from prime. Please complete the “*Comments*” area, sign, date, and fax the **project completion report** only to 517-335-0945 or email to [mdot-paymentstatements@michigan.gov](mailto:mdot-paymentstatements@michigan.gov) within 7 days of receipt from prime.

MDOT Office of Business Development  
P.O. Box 30050  
Lansing, Michigan 48909  
Questions about this form? Call Toll-free, 1866-DBE-1264



**STATE ADMINISTRATIVE BOARD**

**RESOLUTION 2011-2**

**PROCEDURES APPLICABLE TO MDOT CONTRACTS AND GRANTS  
AND  
RESCISSION OF RESOLUTIONS 2003-2 and 2005-2**

WHEREAS, the State Administrative Board ("Board") exercises general supervisory control over the functions and activities of all administrative departments, boards, commissioners, and officers of this State, and of all State institutions pursuant to Section 3 of 1921 PA 2, MCL 17.3;

WHEREAS, the Board may adopt rules governing its procedures and providing for the general conduct of its business and affairs pursuant to Section 2 of 1921 PA 2, MCL 17.2;

WHEREAS, exercising its power to adopt rules, the Board adopted Resolution 2003-1 on March 4, 2003, lowering the threshold for Board approval of all new contracts, grants and amendments to \$25,000 or more for the purchase of materials or services unless specifically approved by the Governor, and simultaneously adopted Resolution 2003-2 setting forth certain exceptions to Resolution 2003-1;

WHEREAS, the Board has adopted Resolution 2011-1, raising the threshold for Board approval of all new contracts and grants to \$250,000 or more and of all amendments to \$125,000 or more, and rescinding Resolution 2003-1;

WHEREAS, the Michigan Department of Transportation ("MDOT") is a party to a considerable number of contracts, the majority of which are funded via grants administered by federal agencies including the U.S. Department of Transportation's Federal Highway Administration, Federal Transit Administration, Federal Railroad Administration and Federal Aviation Administration, which oversee MDOT's administration of such contracts and amendments thereto;

WHEREAS, MDOT has implemented internal procedures to assure the proper expenditure of state and federal funds and is subject to financial and performance audits by the Office of Commission Audits pursuant to 1982 PA 438, MCL 247.667a;

WHEREAS, MDOT is a party to a significant number of contracts which by their nature involve substantial consideration and often require amendments arising out of changes in scope, differing field conditions and design errors and omissions;

WHEREAS, delays in the approval of amendments to contracts can result in: postponement of payments to subcontractors and suppliers; work slow downs and stoppages; delays in the completion of projects; exposure to additional costs; and exposure to litigation arising out of contractor claims; and

WHEREAS, recognizing the Board's duty to promote the efficiency of State Government, the Board resolves as follows:

1. Resolution 2003-2 is rescinded.
2. Resolution 2005-2 is rescinded.
3. A contract for professional design, engineering or consulting services requiring MDOT prequalification in connection with the construction or physical improvement of a street, road, highway, bridge, transit or rail system, airport or other structure congruous with transportation ("Professional Engineering Consultant Contract") or a contract for the construction or physical improvement of a street, road, highway, bridge, transit or rail system, airport or other structure congruous with transportation ("Construction Contract") must be approved by the Board prior to execution by MDOT if the amount of the contract is \$500,000 or more. MDOT may obtain approval of the solicitation of a Professional Engineering Consultant Contract or a Construction Contract which, based on the estimate prepared by an engineer employed by the State of Michigan, is estimated to be \$500,000 or more. A contract arising out of such solicitation must be approved by the Board prior to execution by MDOT if the amount of the contract exceeds 110% of the State engineer's estimate.
4. An amendment to a Professional Engineering Consultant Contract or a Construction Contract must be approved by the Board prior to execution by MDOT if the amount of the amendment and the sum of all previous amendments exceeds 10% of the original contract, except that an amendment to a Professional Engineering Consultant Contract or a Construction Contract need not be approved by the Board if: a) approved in accordance with applicable federal law or procedure by a representative of a federal agency contributing funds to the project that is the subject of the contract; or b) approved in accordance with MDOT's internal procedures provided the procedures include approval by at least one MDOT employee who has managerial responsibility and is neither the project manager nor directly involved in the administration of the project.
5. A contract for services not requiring MDOT prequalification ("Service Contract") in the amount of \$250,000 or more must be approved by the Board prior to execution by MDOT. A Service Contract does not include a Professional Engineering Consultant Contract or a Construction Contract.
6. An amendment to a Service Contract must be approved by the Board prior to execution by MDOT if the amount of the amendment and the sum of all previous amendments total \$125,000 or more. Thereafter, an amendment to a Service Contract must be approved by the Board if the amount of the amendment and the sum of all amendments executed after the most recent Board approval total \$125,000 or more.
7. A contract involving the conveyance of any real property interest under the jurisdiction of MDOT must be approved by the Board prior to execution by MDOT if the fair market value of the interest is \$250,000 or more. Fair market value must be determined in accordance with procedures approved by the State Transportation Commission.

8. MDOT may enter into a contract with a sub-recipient without approval of the Board if: a) the purpose of the contract is to provide federal or state matching funds for a project; b) MDOT has been authorized by an agency administering any federal funds to award them to the sub-recipient; and c) the sub-recipient has agreed to fully reimburse the State in the event the sub-recipient does not use the funds in accordance with the purpose of the funding. A sub-recipient includes, but is not limited to, a local unit of government, a governmental authority, a private non-profit entity, a railroad or a rail service provider.

9. MDOT may enter into a cost participation contract with a local unit of government without approval of the Board if: a) the contract involves the construction or physical improvement of a street, road, highway, bridge or other structure congruous with transportation; b) the construction or improvement is funded by federal, state or local funds; and c) the contract is approved by each entity providing funds or in accordance with applicable law.

10. MDOT may enter into a contract in connection with the award of a grant, including state matching funds, to a local unit of government, a governmental authority, a private non-profit entity, a railroad or a rail service provider, without approval of the Board if the contract provides that the recipient will fully reimburse the State in the event grant funds are not used in accordance with the terms of the grant.

11. MDOT may enter into a contract with an airport sponsor without approval of the Board if the contract has been approved by the Michigan Aeronautics Commission.

12. MDOT may enter into a contract or award a grant without approval of the Board in situations where emergency action is required. For all emergency contracts or grants of \$250,000 or more, MDOT must transmit to the Board a written report setting forth the nature of the emergency and the key terms of the contract or grant within 30 days of executing the contract or awarding the grant.

13. Notwithstanding any provision of this resolution, the Board may require MDOT to report the status of any project and may require MDOT to obtain Board approval of any contract, grant or any amendment to a contract.

This Resolution is effective \_\_\_\_\_, 2011.

**APPROVED**  
State  
Administrative Board

*8/30/11 Rose M. Cousin*



**ALLEGAN COUNTY ROAD COMMISSION**

**PROGRESS CLAUSE**

1 of 1

Wightman & Associates, Inc./AJN

08/07/2014

Start work within ten (10) days after receiving notice of award of contract or on or before the date designated as the starting date in the Detailed Progress Schedule, whichever is later. In no case shall any work be commenced prior to receipt of formal notice of award by the Department.

All trees shall be cut and down before April 1, 2015. The entire project shall be completed no later than July 24, 2015.

The approved low bidder(s) for the work covered by this proposal will be required to participate in a pre-construction meeting with MDOT, the Allegan County Road Commission, and/or representatives. The schedule for this meeting will be set within one week after the project award.

The named subcontractor(s) for Specialty and/or Designated Items (if such items are designated in the proposal) which materially affect the work schedule, shall also be present at the scheduled meeting.

The Project Engineer will arrange the time and place for the meeting.

The Progress Schedule shall include, as a minimum, the controlling work items for the completion of the project and the planned dates (or work day for a work day project) that these work items will be controlling operations. When specified in the bidding proposal, the date the project is to be opened to traffic as well as the final project completion date shall also be included in the Detailed Progress Schedule.

If the Bidding Proposal specifies other controlling dates, these shall also be included in the Progress Schedule.

**ALLEGAN COUNTY ROAD COMMISSION**

**SPECIAL PROVISION**

**FOR**

**TRAFFIC MAINTENANCE AND CONTROL**

1 of 3

Wightman & Associates, Inc./AJN

08/07/2014

**a. Description.** This work shall consist of work at the intersection of 16<sup>th</sup> Street and 120<sup>th</sup> Avenue in Watson Township, Allegan County.

**b. General.** Traffic shall be maintained according to Sections 104.11, 812 and 922 of the Michigan Department of Transportation *2012 Standard Specifications for Construction*, the Michigan Manual of Uniform Traffic Control Devices (MMUTCD), and any Supplemental Specifications, and as herein specified.

1. The Contractor shall notify the Engineer, local police department, local fire department, and other emergency response units a minimum of **72 business hours** prior to the implementation of any detours, road closures, lane closures and major traffic shifts.
2. The Contractor shall coordinate his operations with Contractors performing work on other projects within or adjacent to the Construction Influence Area (CIA) as described below. The Contractor shall note Section 104.08 of the MDOT Standard Specifications for Construction for the requirement of cooperation with other contractors.
  - There are no projects currently scheduled to be constructed in the vicinity of this project.
3. County and/or Local maintenance crews and/or Contract Maintenance Agencies may perform maintenance work within or adjacent to the Construction Influence Area (CIA). The Contract Maintenance Agency will coordinate their operations with the Engineer to minimize the interference to the Contractor. No additional payment will be made to the Contractor for the joint use of the traffic control items.
4. During all times of construction, access to all residential drives for emergency vehicles and local residents shall be maintained by the Contractor until the project is completed, unless closure is approved by the Engineer. This work will not be paid for separately, but shall be included in payment for Minor Traf Devices.
5. Open excavations and/or trenches that are left open overnight shall be protected to prevent access to it by the general public. Payment is included in Minor Traf Devices.

**c. Construction Influence Area (CIA).** The CIA shall include the right-of-way of the following roadways, within the approximate limits described below:

1. 16<sup>th</sup> Street from 1000' south of the P.O.B. to 1000' north of the P.O.E.
2. 120<sup>th</sup> Avenue from approximately 2,000' west of 16<sup>th</sup> Street to 2,000' east of 16<sup>th</sup> Street.

**d. Traffic Restrictions.**

1. No work shall be performed during the Memorial Day, 4<sup>th</sup> of July and Labor Day holiday periods, as defined by the Engineer.
2. Work shall only be performed between the hours of 7am to 7pm (Monday – Friday). Work outside of these posted times will be at the discretion of the Engineer and any additional cost for maintaining traffic shall be borne by the Contractor.
3. No work shall be performed on Saturday or Sunday, unless approved by the Engineer in writing. Contractor shall request permission to work no later than 12:00 (noon) the Wednesday prior to the weekend he is requesting to work.
4. The minimum lane width throughout the CIA shall be 10 foot, where access is provided.

**e. Stage Construction.** The traffic control required by this Special Provision for work on 16<sup>th</sup> Street and 120<sup>th</sup> Avenue is based upon a complete closure as shown in the plans. Tree clearing operations shall be completed utilizing a shoulder closure signing sequence. An alternate traffic control plan may be used by the contractor, subject to review and approval by the Engineer. Alternate traffic control plans shall be submitted to the Engineer with adequate time to review and comment prior to implementation.

**f. Traffic Control Devices.**

1. General

- A. All traffic control devices and their usage shall conform to the Michigan Manual of Uniform Traffic Control Devices (MMUTCD), current edition, and as specified herein.
- B. During non-working periods, any work site with uncompleted work shall have advance signs (W21-4 – “Road Work Ahead”) and Plastic Drums, at specific locations, as directed by the Engineer, at no additional cost to the Allegan County Road Commission.
- C. During construction, access to all residential drives shall be maintained.
- D. Temporary warning, regulatory and guide signs not applicable to the current traffic operation or road closure shall be removed, covered, or laid down with the legs removed as directed by the Project Engineer.
- E. All traffic control devices damage by construction activities shall be replaced at the Contractor’s expense.

2. Temporary Signs

- A. Fabrication, installation, and removal of temporary signs shall be the responsibility of the Contractor and shall be included in the pay items for **Sign, Type \_ , Temp, Prismatic, Furn.**

- B. All diamond-shaped warning signs shall be 48in x 48in mounted at a 5 foot minimum bottom height in uncurbed areas, and 7 foot minimum bottom height in curbed or pedestrian areas.
- C. Distances shown between construction warning, regulatory and guide signs shown on the Michigan Department of Transportation Maintaining Traffic Typical M0020 are approximate and may require field adjustment, as directed by the Engineer.
- D. All temporary signs shall be constructed with legends and symbols flush to the signs face and not extending beyond the sign borders or edges.
- E. All temporary signs that will be in place for more than 14 Days shall be mounted on ground driven sign supports per Michigan Department of Transportation Maintaining Traffic Typical WZD-100-A, unless approved by Engineer to leave on stands. The cost to maintain signs whether driven on posts or sandbagged will be included in payment for **Sign, Type 1, Temp, Prismatic, Oper.**
- F. Any additional signs required for maintaining traffic shall be approved by the Engineer prior to placement and shall be paid for at the contract unit prices.

### 3. Permanent Signing

- A. The Allegan County Road Commission will handle the removal and installation of all permanent signing on this project.
- B. Contractor shall provide the Road Commission with a minimum of three (3) days advance notice to remove signs that interfere with Contractors operations.
- C. Road Commission work will be conducted utilizing the Contractors traffic control setup. No additional compensation will be allowed for the joint use of traffic control devices.

### 4. Channelizing Devices

- A. **Barricade, Type III, High Intensity, Double Sided, Furn** shall have high intensity sheeting on both sides of the rail and shall be 8 feet in length unless otherwise specified. All type III barricades shall be in conformance with Michigan Department of Transportation Maintaining Traffic Typical WZD-125-E.

**g. Dust Control.** Per Section 107.15.A.1. of the Michigan Department of Transportation 2012 Standard Specifications for Construction, Contractor shall maintain dust control on this project throughout the construction schedule.

**h. Measurement and Payment.** The estimate of quantities for maintaining traffic on this project are based on the signing and related traffic control devices described in this Special Provision and payment for these devices shall be according to Section 812.04 of the MDOT *2012 Standard Specifications for Construction* unless otherwise specified.



### MINIMUM MERGING TAPER LENGTH "L" (FEET)

OFFSET FEET	POSTED SPEED LIMIT, MPH (PRIOR TO WORK AREA)									
	25	30	35	40	45	50	55	60	65	70
1	10	15	20	27	45	50	55	60	65	70
2	21	30	41	53	90	100	110	120	130	140
3	31	45	61	80	135	150	165	180	195	210
4	42	60	82	107	180	200	220	240	260	280
5	52	75	102	133	225	250	275	300	325	350
6	63	90	123	160	270	300	330	360	390	420
7	73	105	143	187	315	350	385	420	455	490
8	83	120	163	213	360	400	440	480	520	560
9	94	135	184	240	405	450	495	540	585	630
10	104	150	204	267	450	500	550	600	650	700
11	115	165	225	293	495	550	605	660	715	770
12	125	180	245	320	540	600	660	720	780	840
13	135	195	266	347	585	650	715	780	845	910
14	146	210	286	374	630	700	770	840	910	980
15	157	225	307	400	675	750	825	900	975	1050

TAPER LENGTH "L" IN FEET

THE FORMULAS FOR THE MINIMUM LENGTH OF A MERGING TAPER IN DERIVING THE "L" VALUES SHOWN IN THE ABOVE TABLES ARE AS FOLLOWS:

"L" =  $\frac{W \times S^2}{60}$  WHERE POSTED SPEED PRIOR TO THE WORK AREA IS 40 MPH OR LESS

"L" = S x W WHERE POSTED SPEED PRIOR TO THE WORK AREA IS 45 MPH OR GREATER

- L = MINIMUM LENGTH OF MERGING TAPER
- S = POSTED SPEED LIMIT IN MPH PRIOR TO WORK AREA
- W = WIDTH OF OFFSET

#### TYPES OF TAPERS

##### UPSTREAM TAPERS

- MERGING TAPER
- SHIFTING TAPER
- SHOULDER TAPER
- TWO-WAY TRAFFIC TAPER

##### DOWNSTREAM TAPERS (USE IS OPTIONAL)

#### TAPER LENGTH

- L - MINIMUM
- 1/2 L - MINIMUM
- 1/3 L - MINIMUM
- 100' - MAXIMUM
- 100' - MINIMUM (PER LANE)

 TRAFFIC AND SAFETY MAINTAINING TRAFFIC TYPICAL	TABLES FOR "L", "D" AND "B" VALUES		
	DRAWN BY: CON:AE:djf	JUNE 2006	M0020a
CHECKED BY: BMM	PLAN DATE:	1 OF 2	
FILE: R:/DGN/TSR/STDS/ENGLISH/MNTTRF/M0020a.dgn		REV.	08/21/2006

DISTANCE BETWEEN TRAFFIC CONTROL DEVICES "D"  
AND LENGTH OF LONGITUDINAL BUFFER SPACE ON  
"WHERE WORKERS PRESENT" SEQUENCES

"D" DISTANCES	POSTED SPEED LIMIT, MPH (PRIOR TO WORK AREA)									
	25	30	35	40	45	50	55	60	65	70
D (FEET)	250	300	350	400	450	500	550	600	650	700

GUIDELINES FOR LENGTH OF  
LONGITUDINAL BUFFER SPACE "B"

SPEED* MPH	LENGTH FEET
20	33
25	50
30	83
35	132
40	181
45	230
50	279
55	329
60	411
65	476
70	542

\* POSTED SPEED, OFF PEAK 85TH PERCENTILE SPEED PRIOR TO WORK STARTING, OR THE ANTICIPATED OPERATING SPEED

1 BASED UPON AMERICAN ASSOCIATION OF STATE HIGHWAY AND TRANSPORTATION OFFICIALS (AASHTO) BRAKING DISTANCE PORTION OF STOPPING SIGHT DISTANCE FOR WET AND LEVEL PAVEMENTS (A POLICY ON GEOMETRIC DESIGN OF HIGHWAY AND STREETS), AASHTO. THIS AASHTO DOCUMENT ALSO RECOMMENDS ADJUSTMENTS FOR THE EFFECT OF GRADE ON STOPPING AND VARIATION FOR TRUCKS.

 Michigan Department of Transportation TRAFFIC AND SAFETY MAINTAINING TRAFFIC TYPICAL	TABLES FOR "L", "D" AND "B" VALUES		
	DRAWN BY: CON:AE:djf CHECKED BY: BMM	JUNE 2006 PLAN DATE:	M0020a
FILE: R:/DGN/TSR/STDS/ENGLISH/MNTTRF/M0020a.dgn      REV. 08/21/2006			

SIGN PLACEMENT IS THE SAME FOR BOTH DIRECTIONS

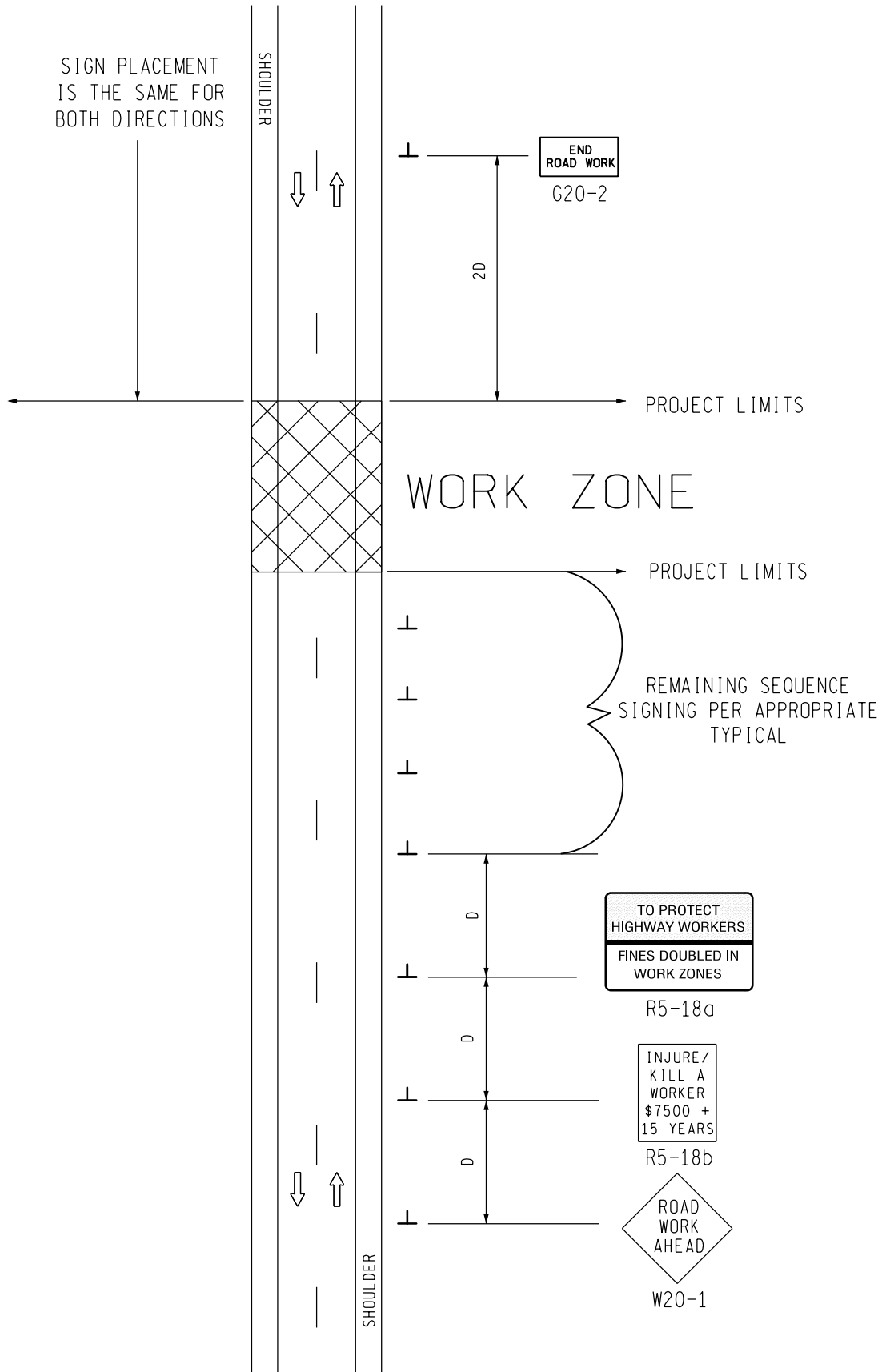

SIGN = 68 f+2 - TYPE B  
FOR ONE DIRECTION OF TRAFFIC  
W20-1 QUANTITY INCLUDED  
WITH APPROPRIATE TYPICAL  
FOR SEQUENCE SIGNING

**MDOT**  
Michigan Department of Transportation  
TRAFFIC AND SAFETY  
MAINTAINING TRAFFIC  
TYPICAL

TYPICAL ADVANCE SIGNING TREATMENT FOR LONG, INTERMEDIATE AND SHORT TERM STATIONARY WORK ZONE OPERATIONS OF LESS THAN TWO MILES IN LENGTH WHERE TRAFFIC CONTROL DEVICES MAY REMAIN AT END OF WORK DAY ON AN UNDIVIDED TWO-WAY ROADWAY

DRAWN BY: CON:AE:djf  
CHECKED BY: BMM:CRB

OCTOBER 2011  
PLAN DATE:

M0040a

SHEET  
1 OF 2

NOT TO SCALE

FILE: PW RD/TS/Typicals/Signs/MT NON FWY/M0040a.dgn REV. 10/13/2011

## NOTES

30. THE APPROPRIATE ADVANCE SIGNING SEQUENCE(S), (M0030a THROUGH M0080a) SHALL BE USED ON ALL PROJECTS.
32. THESE SIGNS SHALL BE LEFT IN PLACE AT THEIR PRESCRIBED LOCATIONS FOR THE DURATION OF THE PROJECT AND UNTIL ALL TEMPORARY TRAFFIC CONTROL HAS BEEN REMOVED.
35. THESE SIGNS ARE INTENDED TO BE USED WITHIN THE LIMITS OF THE TEMPORARY SEQUENCE SIGNING AS IS SHOWN ON 1 OF 2. THESE SIGNS ARE NOT TO BE INTERMINGLED WITH ANY OTHER TEMPORARY SEQUENCE SIGNING EXCEPT AS SHOWN.

## SIGN SIZES

G20-2	-	48" x 24"
R5-18a	-	96" x 60"
R5-18b	-	48" x 60"
W20-1	-	48" x 48"

 TRAFFIC AND SAFETY MAINTAINING TRAFFIC TYPICAL	TYPICAL ADVANCE SIGNING TREATMENT FOR LONG, INTERMEDIATE AND SHORT TERM STATIONARY WORK ZONE OPERATIONS OF LESS THAN TWO MILES IN LENGTH WHERE TRAFFIC CONTROL DEVICES MAY REMAIN AT END OF WORK DAY ON AN UNDIVIDED TWO-WAY ROADWAY	
	DRAWN BY: CON:AE:djf	OCTOBER 2011
CHECKED BY: BMM:CRB	PLAN DATE:	2 OF 2
FILE: PW RD/TS/Typicals/Signs/MT NON FWY/M0040a.dgn REV. 10/13/2011		

NOT TO SCALE

SIGN PLACEMENT  
IS THE SAME FOR  
BOTH DIRECTIONS

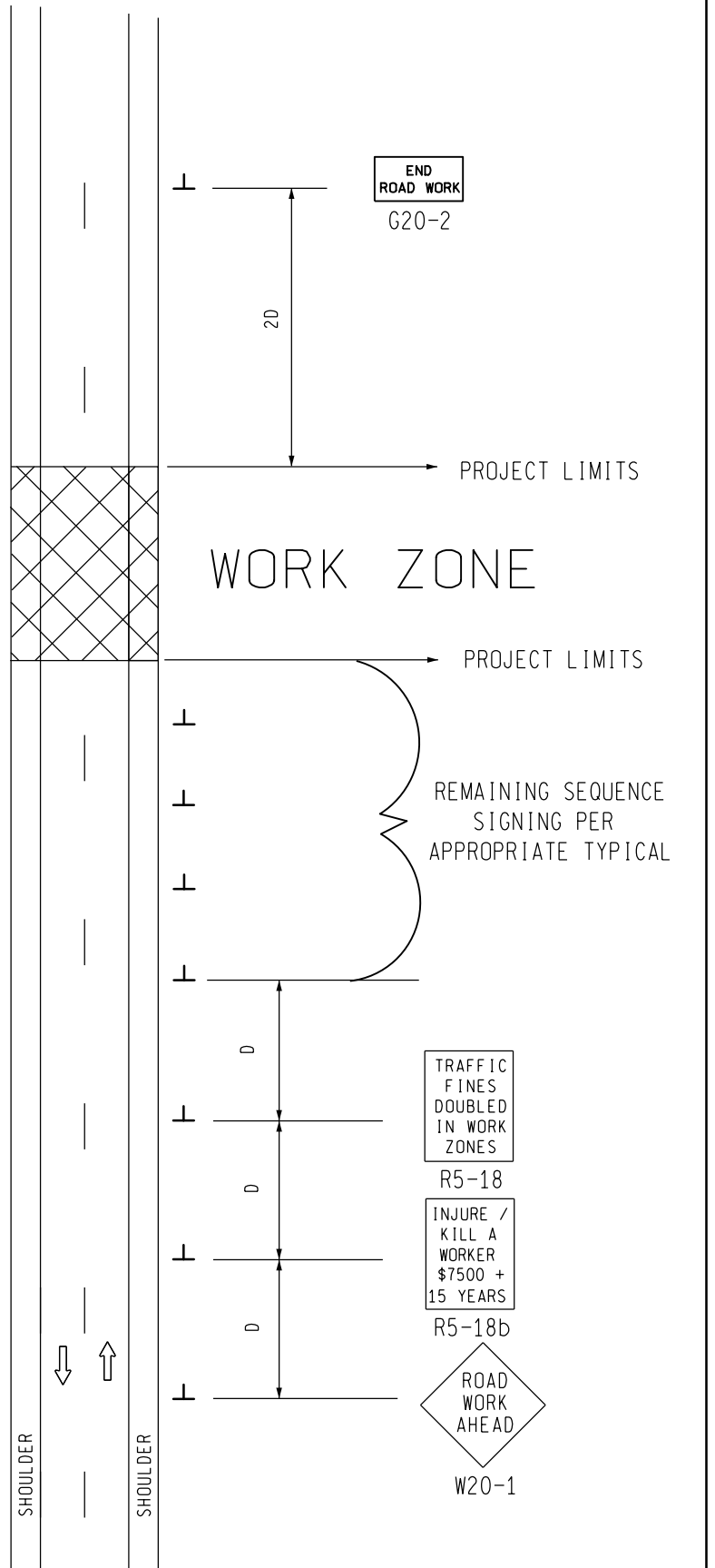
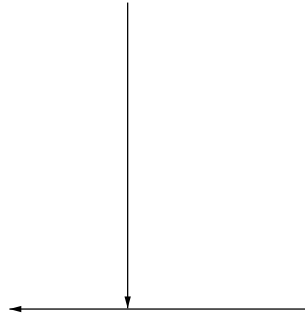

SIGN = 48 f+2 - TYPE B  
FOR ONE DIRECTION OF TRAFFIC  
W20-1 QUANTITY INCLUDED WITH  
APPROPRIATE TYPICAL FOR  
SEQUENCE SIGNING

<p>TRAFFIC AND SAFETY MAINTAINING TRAFFIC TYPICAL</p>	<p>TYPICAL ADVANCE SIGNING TREATMENT FOR INTERMEDIATE AND SHORT TERM STATIONARY WORK ZONE OPERATIONS WHERE ALL TRAFFIC CONTROL DEVICES ARE REMOVED AT END OF EACH WORK DAY ON AN UNDIVIDED TWO-WAY ROADWAY</p>	
	<p>DRAWN BY: CON:AE:djf CHECKED BY: BMM:CRB</p>	<p>OCTOBER 2011 PLAN DATE:</p>
<p>FILE: PW RD/TS/Typicals/Signs/MT NON FWY/M0050a.dgn REV. 10/13/2011</p>		

NOT TO SCALE

## NOTES

30. THE APPROPRIATE ADVANCE SIGNING SEQUENCE(S), (M0030a THROUGH M0080a) SHALL BE USED ON ALL PROJECTS.
35. THESE SIGNS ARE INTENDED TO BE USED WITHIN THE LIMITS OF THE TEMPORARY SEQUENCE SIGNING AS IS SHOWN ON 1 OF 2. THESE SIGNS ARE NOT TO BE INTERMINGLED WITH ANY OTHER TEMPORARY SEQUENCE SIGNING EXCEPT AS SHOWN.



### SIGN SIZES

G20-2	-	48" x 24"
R5-18	-	48" x 60"
R5-18b	-	48" x 60"
W20-1	-	48" x 48"

 TRAFFIC AND SAFETY MAINTAINING TRAFFIC TYPICAL	TYPICAL ADVANCE SIGNING TREATMENT FOR INTERMEDIATE AND SHORT TERM STATIONARY WORK ZONE OPERATIONS WHERE ALL TRAFFIC CONTROL DEVICES ARE REMOVED AT END OF EACH WORK DAY ON AN UNDIVIDED TWO-WAY ROADWAY	
	DRAWN BY: CON:AE:djf	OCTOBER 2011
CHECKED BY: BMM:CRB	PLAN DATE:	2 OF 2
FILE: PW RD/TS/Typicals/Signs/MT NON FWY/M0050a.dgn REV. 10/13/2011		

NOT TO SCALE

**KEY**

- • • CHANNELIZING DEVICES
-  LIGHTED ARROW PANEL (CAUTION MODE)
-  TRAFFIC FLOW
- REFLECTS EXISTING SPEED LIMIT
- \* USE THE "NEXT -- MILES" SIGN WHEN SHOULDER CLOSURE EXCEEDS 1 MILE IN LENGTH

SIGN = 120 ft± - TYPE B  
 W/PLAQUE = 132 ft± - TYPE B  
 PLUS ADDITIONAL R2-1's  
 THROUGHOUT WORK AREA

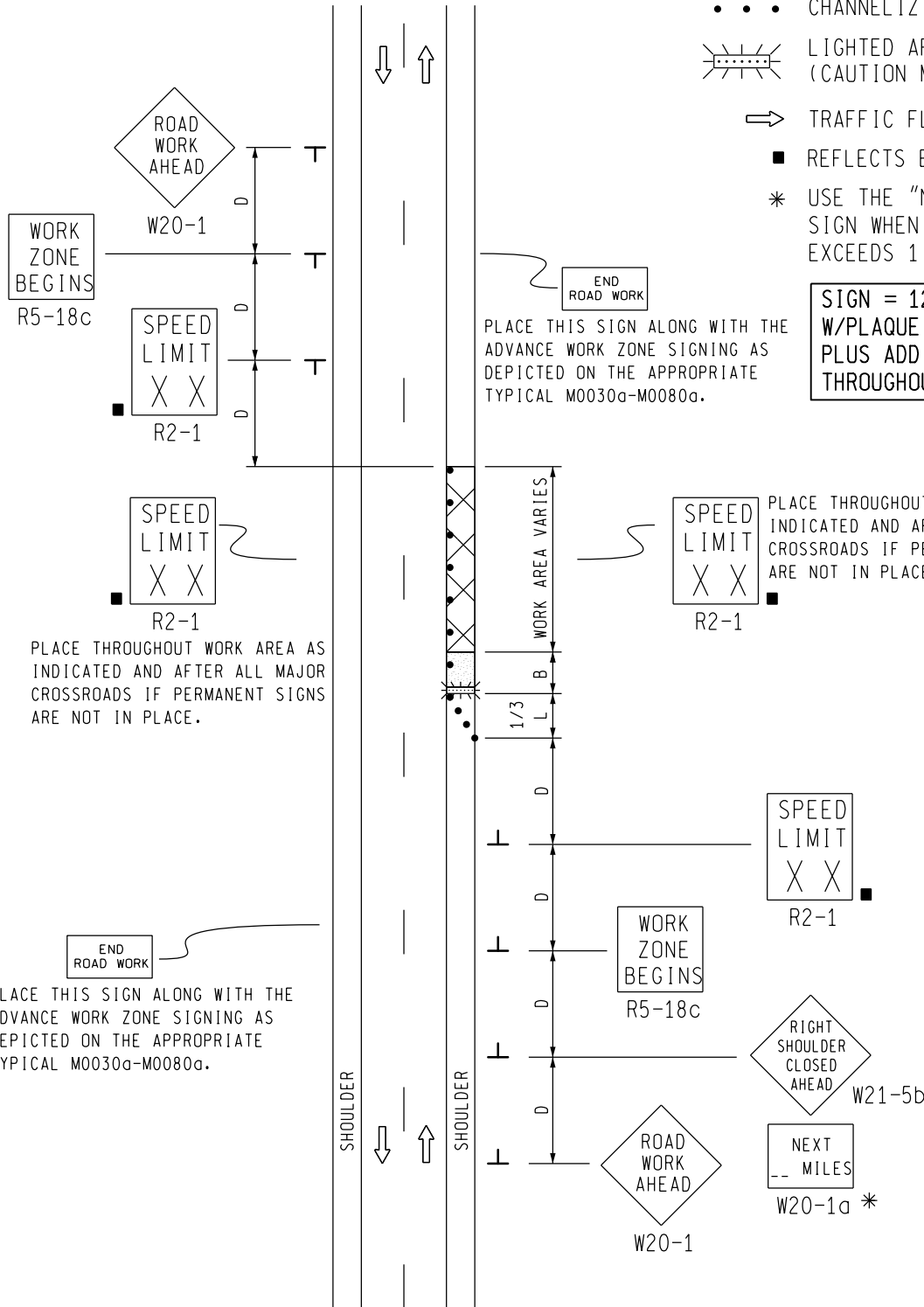

END ROAD WORK  
 PLACE THIS SIGN ALONG WITH THE ADVANCE WORK ZONE SIGNING AS DEPICTED ON THE APPROPRIATE TYPICAL M0030a-M0080a.

PLACE THROUGHOUT WORK AREA AS INDICATED AND AFTER ALL MAJOR CROSSROADS IF PERMANENT SIGNS ARE NOT IN PLACE.

PLACE THROUGHOUT WORK AREA AS INDICATED AND AFTER ALL MAJOR CROSSROADS IF PERMANENT SIGNS ARE NOT IN PLACE.

END ROAD WORK  
 PLACE THIS SIGN ALONG WITH THE ADVANCE WORK ZONE SIGNING AS DEPICTED ON THE APPROPRIATE TYPICAL M0030a-M0080a.

 Michigan Department of Transportation TRAFFIC AND SAFETY MAINTAINING TRAFFIC TYPICAL	TYPICAL TEMPORARY TRAFFIC CONTROL FOR A SHOULDER CLOSURE ON A TWO LANE TWO-WAY ROADWAY NO SPEED REDUCTION	
	DRAWN BY: CON:AE:djf CHECKED BY: BMM:CRB	OCTOBER 2011 PLAN DATE:
FILE: PW RD/TS/Typicals/Signs/MT NON FWY/M0110a.dgn REV. 10/04/2011		

NOT TO SCALE

## NOTES

1. D = DISTANCE BETWEEN TRAFFIC CONTROL DEVICES  
 $1/3 L$  = MINIMUM LENGTH OF TAPER  
 B = LENGTH OF LONGITUDINAL BUFFER  
 SEE **M0020a** FOR "D," "L," AND "B" VALUES
2. ALL NON-APPLICABLE SIGNING WITHIN THE CIA SHALL BE MODIFIED TO FIT CONDITIONS, COVERED OR REMOVED.
3. DISTANCES BETWEEN SIGNS, THE VALUES FOR WHICH ARE SHOWN IN TABLE D, ARE APPROXIMATE AND MAY NEED ADJUSTING AS DIRECTED BY THE ENGINEER.
- 3A. THE "WORK ZONE BEGINS" (R5-18c) SIGN SHALL BE USED ONLY IN THE INITIAL SIGNING SEQUENCE IN THE WORK ZONE. SUBSEQUENT SEQUENCES IN THE SAME WORK ZONE SHALL OMIT THIS SIGN AND THE QUANTITIES SHALL BE ADJUSTED APPROPRIATELY.
- 4E. THE MAXIMUM RECOMMENDED DISTANCE(S) BETWEEN CHANNELIZING DEVICES SHOULD BE EQUAL IN FEET TO THE POSTED SPEED IN MILES PER HOUR ON TAPER(S) AND TWICE THE POSTED SPEED IN THE PARALLEL AREA(S).
5. FOR OVERNIGHT CLOSURES, TYPE III BARRICADES SHALL BE LIGHTED.
6. WHEN CALLED FOR IN THE FHWA ACCEPTANCE LETTER FOR THE SIGN SYSTEM SELECTED, THE TYPE A WARNING FLASHER, SHOWN ON THE WARNING SIGNS, SHALL BE POSITIONED ON THE SIDE OF THE SIGN NEAREST THE ROADWAY.
7. ALL TEMPORARY SIGNS, TYPE III BARRICADES, THEIR SUPPORT SYSTEMS AND LIGHTING REQUIREMENTS SHALL MEET NCHRP 350 CRASHWORTHLY REQUIREMENTS STIPULATED IN THE CURRENT EDITION OF THE MICHIGAN MANUAL ON UNIFORM TRAFFIC CONTROL DEVICES, THE CURRENT EDITION OF THE STANDARD SPECIFICATIONS FOR CONSTRUCTION, THE STANDARD PLANS AND APPLICABLE SPECIAL PROVISIONS. ONLY DESIGNS AND MATERIALS APPROVED BY MDOT WILL BE ALLOWED.
8. WHEN BUFFER AREAS ARE ESTABLISHED, THERE SHALL BE NO EQUIPMENT OR MATERIALS STORED OR WORK CONDUCTED IN THE BUFFER AREA.
- 29A. THE TYPE OF REFLECTIVE SHEETING USED FOR THE W20-1a PLAQUE SHALL BE THE SAME AS THE TYPE USED FOR THE PARENT SIGN.

### SIGN SIZES

DIAMOND WARNING	- 48" x 48"
W20-1a PLAQUE	- 48" x 36"
R2-1 REGULATORY	- 48" x 60"
R5-18c REGULATORY	- 48" x 48"

NOT TO SCALE

 TRAFFIC AND SAFETY MAINTAINING TRAFFIC TYPICAL	TYPICAL TEMPORARY TRAFFIC CONTROL FOR A SHOULDER CLOSURE ON A TWO LANE TWO-WAY ROADWAY NO SPEED REDUCTION	
	DRAWN BY: CON:AE:djf CHECKED BY: BMM:CRB	OCTOBER 2011 PLAN DATE:
FILE: PW RD/TS/Typicals/Signs/MT NON FWY/M0110a.dgn REV. 10/04/2011		







PLACE THROUGHOUT WORK AREA AS INDICATED AND AFTER ALL MAJOR CROSSROADS IF PERMANENT SIGNS ARE NOT IN PLACE.

PLACE THIS SIGN ALONG WITH THE ADVANCE WORK ZONE SIGNING AS DEPICTED ON THE APPROPRIATE TYPICAL M0030a-M0080a.

PLACE THROUGHOUT WORK AREA AS INDICATED AND AFTER ALL MAJOR CROSSROADS IF PERMANENT SIGNS ARE NOT IN PLACE.

PLACE THIS SIGN ALONG WITH THE ADVANCE WORK ZONE SIGNING AS DEPICTED ON THE APPROPRIATE TYPICAL M0030a-M0080a.

**KEY**

-  TRAFFIC REGULATOR
-  CHANNELIZING DEVICES
-  LIGHTED ARROW PANEL (CAUTION MODE)
-  TRAFFIC FLOW
-  REFLECTS EXISTING SPEED LIMIT

SIGN = 200 ft± - TYPE B PLUS ADDITIONAL R2-1's THROUGHOUT WORK AREA

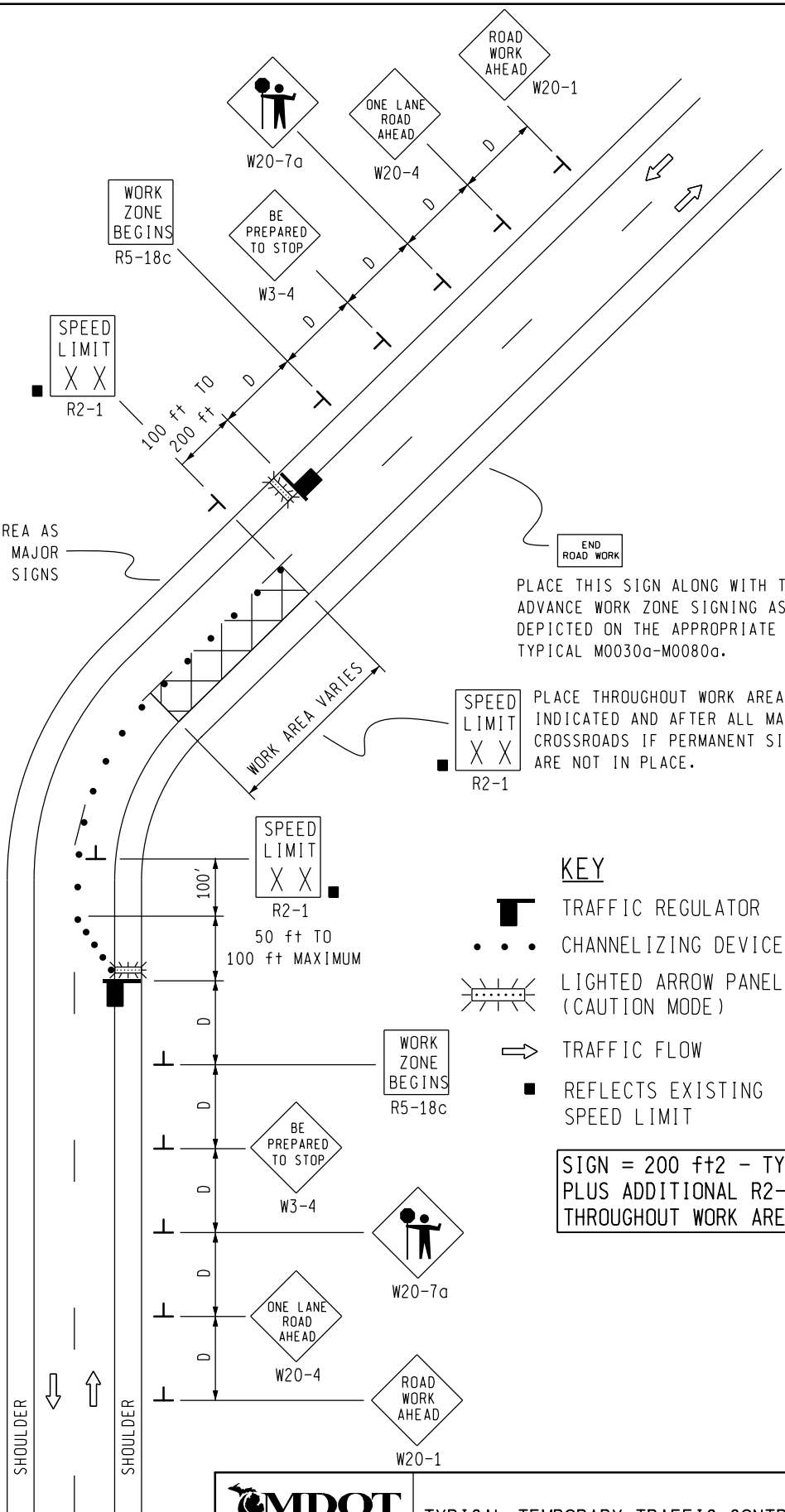

**MDOT**  
Michigan Department of Transportation  
TRAFFIC AND SAFETY  
MAINTAINING TRAFFIC  
TYPICAL

DRAWN BY: CON:AE:djf  
CHECKED BY: BMM:CRB

TYPICAL TEMPORARY TRAFFIC CONTROL FOR A TWO-LANE TWO-WAY ROADWAY WHERE ONE LANE IS CLOSED UTILIZING TRAFFIC REGULATORS, NO SPEED REDUCTION

OCTOBER 2011	M0140a	SHEET 1 OF 2
PLAN DATE:		

NOT TO SCALE

## NOTES

- 1H. D = DISTANCE BETWEEN TRAFFIC CONTROL DEVICES AND LENGTH OF LONGITUDINAL BUFFERS  
SEE **M0020a** FOR "D" VALUES.
2. ALL NON-APPLICABLE SIGNING WITHIN THE CIA SHALL BE MODIFIED TO FIT CONDITIONS, COVERED OR REMOVED.
3. DISTANCES BETWEEN SIGNS, THE VALUES FOR WHICH ARE SHOWN IN TABLE D, ARE APPROXIMATE AND MAY NEED ADJUSTING AS DIRECTED BY THE ENGINEER.
- 3A. THE "WORK ZONE BEGINS" (R5-18c) SIGN SHALL BE USED ONLY IN THE INITIAL SIGNING SEQUENCE IN THE WORK ZONE. SUBSEQUENT SEQUENCES IN THE SAME WORK ZONE SHALL OMIT THIS SIGN AND THE QUANTITIES SHALL BE ADJUSTED APPROPRIATELY.
- 4A. THE MAXIMUM RECOMMENDED DISTANCE(S) BETWEEN CHANNELIZING DEVICES IN THE TAPER AREA(S) SHOULD BE 15 FEET AND SHOULD BE EQUAL IN FEET TO TWICE THE POSTED SPEED IN MILES PER HOUR IN THE PARALLEL AREA(S).
5. FOR OVERNIGHT CLOSURES, TYPE III BARRICADES SHALL BE LIGHTED.
6. WHEN CALLED FOR IN THE FHWA ACCEPTANCE LETTER FOR THE SIGN SYSTEM SELECTED, THE TYPE A WARNING FLASHER, SHOWN ON THE WARNING SIGNS, SHALL BE POSITIONED ON THE SIDE OF THE SIGN NEAREST THE ROADWAY.
7. ALL TEMPORARY SIGNS, TYPE III BARRICADES, THEIR SUPPORT SYSTEMS AND LIGHTING REQUIREMENTS SHALL MEET NCHRP 350 CRASHWORTHLY REQUIREMENTS STIPULATED IN THE CURRENT EDITION OF THE MICHIGAN MANUAL ON UNIFORM TRAFFIC CONTROL DEVICES, THE CURRENT EDITION OF THE STANDARD SPECIFICATIONS FOR CONSTRUCTION, THE STANDARD PLANS AND APPLICABLE SPECIAL PROVISIONS. ONLY DESIGNS AND MATERIALS APPROVED BY MDOT WILL BE ALLOWED.
9. ALL TRAFFIC REGULATORS SHALL BE PROPERLY TRAINED AND SUPERVISED.
- 9A. IN ANY OPERATION INVOLVING MORE THAN ONE TRAFFIC REGULATOR, ONE PERSON SHOULD BE DESIGNATED AS HEAD TRAFFIC REGULATOR.
10. ALL TRAFFIC REGULATORS' CONDUCT, THEIR EQUIPMENT, AND TRAFFIC REGULATING PROCEDURES SHALL CONFORM TO THE CURRENT EDITION OF THE MICHIGAN MANUAL OF UNIFORM TRAFFIC CONTROL DEVICES (MMUTCD) AND THE CURRENT EDITION OF THE MDOT HANDBOOK ENTITLED "TRAFFIC REGULATORS INSTRUCTION MANUAL."
11. WHEN TRAFFIC REGULATING IS ALLOWED DURING THE HOURS OF DARKNESS, APPROPRIATE LIGHTING SHALL BE PROVIDED TO SUFFICIENTLY ILLUMINATE THE TRAFFIC REGULATOR'S STATIONS.
- 12E. THE MAXIMUM DISTANCE BETWEEN THE TRAFFIC REGULATORS SHALL BE NO MORE THAN 2 MILES IN LENGTH UNLESS RESTRICTED FURTHER IN THE SPECIAL PROVISIONS FOR MAINTAINING TRAFFIC. ALL SEQUENCES OF MORE THAN 2 MILES IN LENGTH WILL REQUIRE WRITTEN PERMISSION FROM THE ENGINEER BEFORE PROCEEDING.
13. WHEN INTERSECTING ROADS OR SIGNIFICANT TRAFFIC GENERATORS (SHOPPING CENTERS, MOBILE HOME PARKS, ETC.) OCCUR WITHIN THE ONE-LANE TWO-WAY OPERATION, INTERMEDIATE TRAFFIC REGULATORS AND APPROPRIATE SIGNING SHALL BE PLACED AT THESE LOCATIONS.
14. ADDITIONAL SIGNING AND/OR ELONGATED SIGNING SEQUENCES SHOULD BE USED WHEN TRAFFIC VOLUMES ARE SIGNIFICANT ENOUGH TO CREATE BACKUPS BEYOND THE W3-4 SIGNS.
15. THE HAND HELD (PADDLE) SIGNS REQUIRED BY THE MMUTCD TO CONTROL TRAFFIC WILL BE PAID FOR AS PART OF FLAG CONTROL.
- 28E. THE TRAFFIC REGULATORS SHOULD BE POSITIONED AT OR NEAR THE SIDE OF THE ROAD SO THAT THEY ARE SEEN CLEARLY AT A MINIMUM DISTANCE OF 500 FEET. THIS MAY REQUIRE EXTENDING THE BEGINNING OF THE LANE CLOSURE TO OVERCOME VIEWING PROBLEMS CAUSED BY HILLS AND CURVES.

### SIGN SIZES

DIAMOND WARNING - 48" x 48"  
 R2-1 REGULATORY - 48" x 60"  
 R5-18c REGULATORY - 48" x 48"

NOT TO SCALE

 TRAFFIC AND SAFETY <b>MAINTAINING TRAFFIC          TYPICAL</b>	<b>TYPICAL TEMPORARY TRAFFIC CONTROL FOR          A TWO-LANE TWO-WAY ROADWAY WHERE ONE          LANE IS CLOSED UTILIZING TRAFFIC          REGULATORS, NO SPEED REDUCTION</b>		
DRAWN BY: CON:AE:djf	OCTOBER 2011	M0140a	SHEET
CHECKED BY: BMM:CRB	PLAN DATE:		2 OF 2
FILE: PW RD/TS/Typicals/Signs/MT NON FWY/M0140a.dgn REV. 10/04/2011			

## SIGN MATERIAL SELECTION TABLE

SIGN SIZE	SIGN MATERIAL TYPE		
	TYPE I	TYPE II	TYPE III
≤ 36" X 36"		X	X
>36" X 36" ≤ 96" TO WIDE		X	
> 96" WIDE TO 144" WIDE	X	X	
> 144" WIDE	X		

TYPE I           ALUMINUM EXTRUSION  
 TYPE II          PLYWOOD  
 TYPE III         ALUMINUM SHEET

ROUNDING OF CORNERS IS NOT REQUIRED FOR TYPE I OR II SIGNS.  
 VERTICAL JOINTS ARE NOT PERMITTED.  
 HORIZONTAL JOINTS THROUGH SIGN LEGEND OR SYMBOLS ARE NOT PERMITTED.

## POST SIZE REQUIREMENTS TABLE

SIGN AREA (ft <sup>2</sup> )	POST TYPE		
	U-CHANNEL STEEL	SQUARE TUBULAR STEEL	WOOD
≤9	1 - 3 lb/ft*	1 - 2" 12 or 14 GA*	N/A
9 ≤ 20	2 - 3 lb/ft	2 - 2" 12 or 14 GA	1 - 4" X 6"*
> 20 ≤ 30	N/A	N/A	2 - 4" X 6"
> 30 ≤ 60	N/A	N/A	2 - 6" X 8"
> 60 ≤ 84	N/A	N/A	3 - 6" X 8"

\*SIGNS 4 FEET AND GREATER IN WIDTH REQUIRE 2 POSTS.  
 SIGNS GREATER THAN 8 FEET IN WIDTH REQUIRE 2 OR 3 WOOD  
 POSTS DEPENDING ON AREA OF SIGN.  
 A MAXIMUM OF 2 POSTS WITHIN A 7' PATH IS PERMITTED.

NOT TO SCALE

File:PW/Doc/RD/T&S/Typ/Dev/Sign MainTraf D/WZD-100-A Rev. 8/21/06 ECH

 Michigan Department of Transportation  PREPARED BY TRAFFIC AND SAFETY SUPPORT AREA  DRAWN BY: CON/ECH CHECKED BY: AUG	_____ ENGINEER OF DELIVERY  _____ ENGINEER OF DEVELOPMENT  PENDING _____ FHWA APPROVAL DATE	MICHIGAN DEPARTMENT OF TRANSPORTATION BUREAU OF HIGHWAYS DELIVERY STANDARD PLAN FOR <b>GROUND DRIVEN SIGN          SUPPORTS FOR TEMP SIGNS</b>		
	8/2006	WZD-100-A	SHEET 1 of 11	
	PLAN DATE			

NOTE: THE ORIGINAL SIGNED COPY IS KEPT ON FILE AT THE MICHIGAN DEPARTMENT OF TRANSPORTATION.

## 2 POST SIGN SUPPORT SPACING

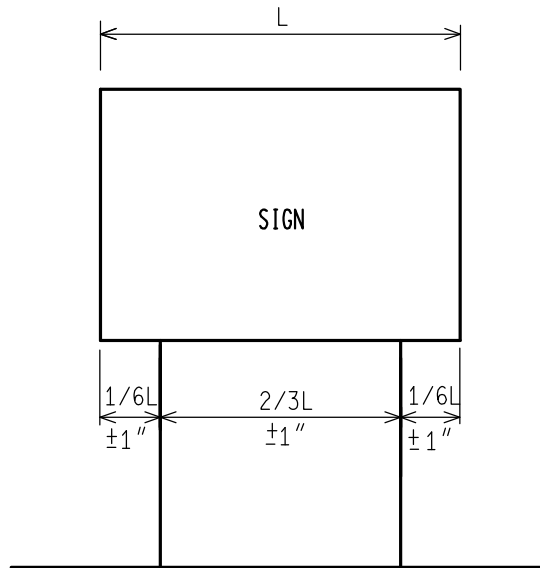

## 3 POST SIGN SUPPORT SPACING

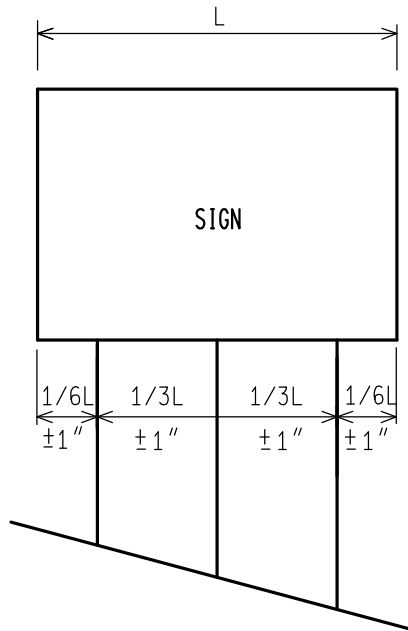

\* FOR ALL 11' AND 12' LONG SIGNS ON 3 WOOD SUPPORTS, SPREAD POSTS SO AS TO HAVE A 8' MIN. TO 9' MAX. DISTANCE BETWEEN OUTSIDE POSTS.

NOT TO SCALE

MICHIGAN DEPARTMENT OF TRANSPORTATION BUREAU OF HIGHWAYS DELIVERY STANDARD PLAN	PENDING FHWA APPROVAL DATE	8/2006 PLAN DATE	WZD-100-A	SHEET 2 of 11
File:PW/Doc/RD/T&S/Typ/Dev/Sign MainTraf D/WZD-100-A Rev. 8/21/06 ECH				

NOTE: THE ORIGINAL SIGNED COPY IS KEPT ON FILE AT THE MICHIGAN DEPARTMENT OF TRANSPORTATION.

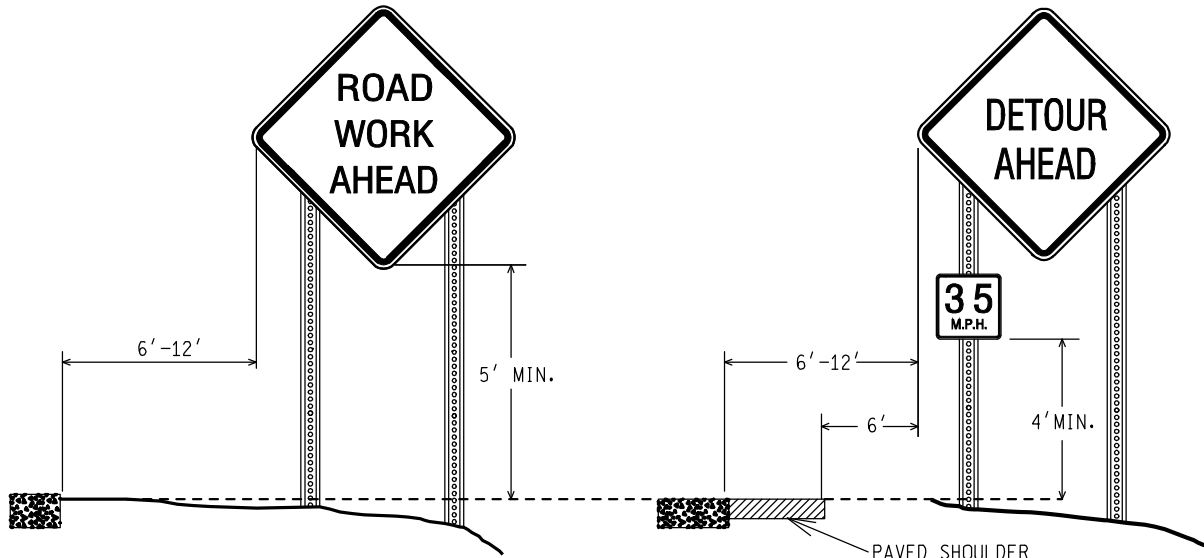

RURAL

RURAL WITH ADVISORY SPEED PLATE

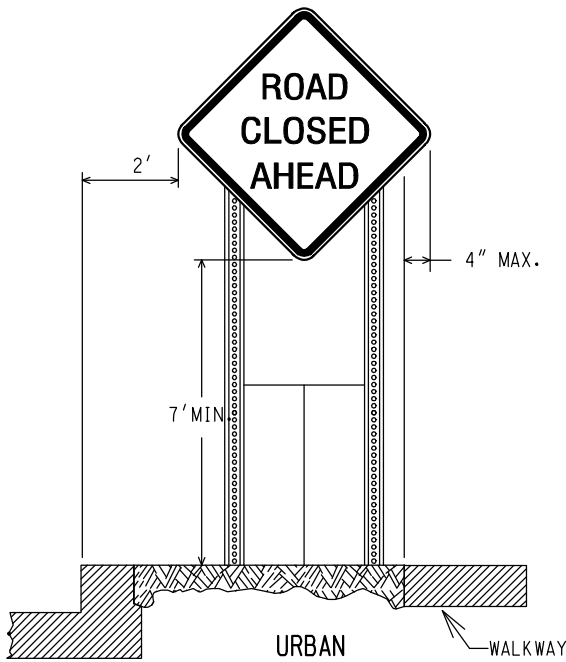

URBAN

WALKWAY

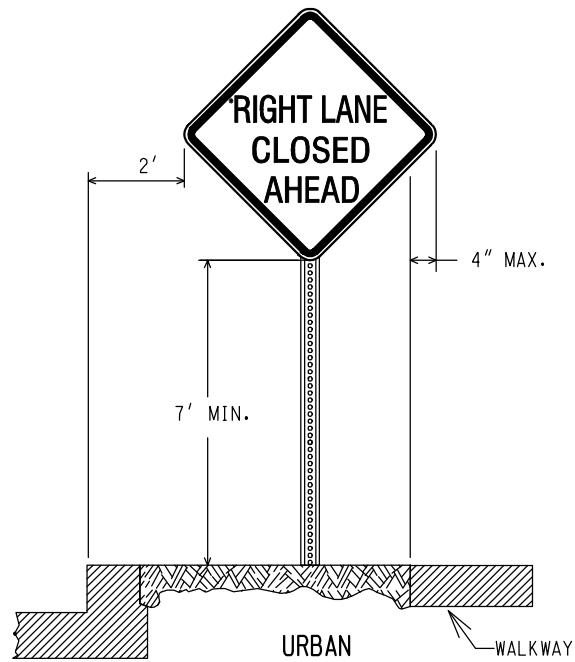

URBAN

WALKWAY

(CURBED AREAS OR WHERE WALKWAYS ARE PRESENT)

(CURBED AREAS OR WHERE WALKWAYS ARE PRESENT)

BOTTOM HEIGHT AND OFFSET

NOT TO SCALE

MICHIGAN DEPARTMENT OF TRANSPORTATION  
BUREAU OF HIGHWAYS DELIVERY STANDARD PLAN

PENDING  
FHWA APPROVAL DATE

8/2006  
PLAN DATE

WZD-100-A

SHEET  
3 of 11

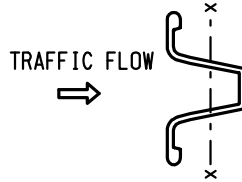
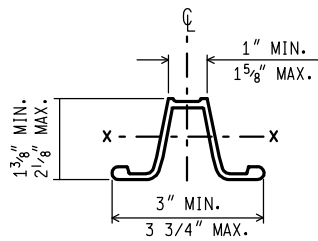
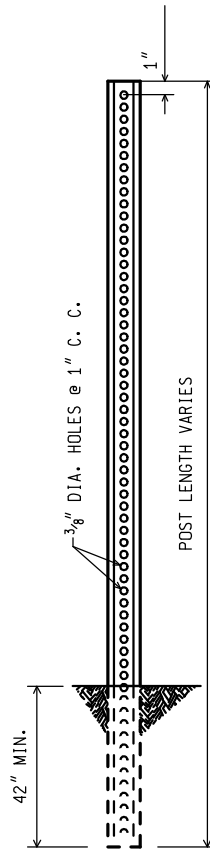

WEIGHT = 3 lbs/ft  
 SECT. MOD. X.-X. = 0.31 CUBIC INCHES MIN.

### 3 lb. U - CHANNEL STEEL POST (NO SPLICE)

MOUNT SIGN ON OPEN FACE OF  
 U - CHANNEL STEEL POST

NOT TO SCALE

MICHIGAN DEPARTMENT OF TRANSPORTATION  
 BUREAU OF HIGHWAYS DELIVERY STANDARD PLAN

PENDING  
 \_\_\_\_\_  
 FHWA APPROVAL DATE

8/2006  
 \_\_\_\_\_  
 PLAN DATE

WZD-100-A

SHEET  
 4 of 11

File:PW/Doc/RD/T&S/Typ/Dev/Sign MainTraf D/WZD-100-A Rev. 8/21/06 ECH

NOTE: THE ORIGINAL SIGNED COPY IS KEPT ON FILE AT THE MICHIGAN DEPARTMENT OF TRANSPORTATION.

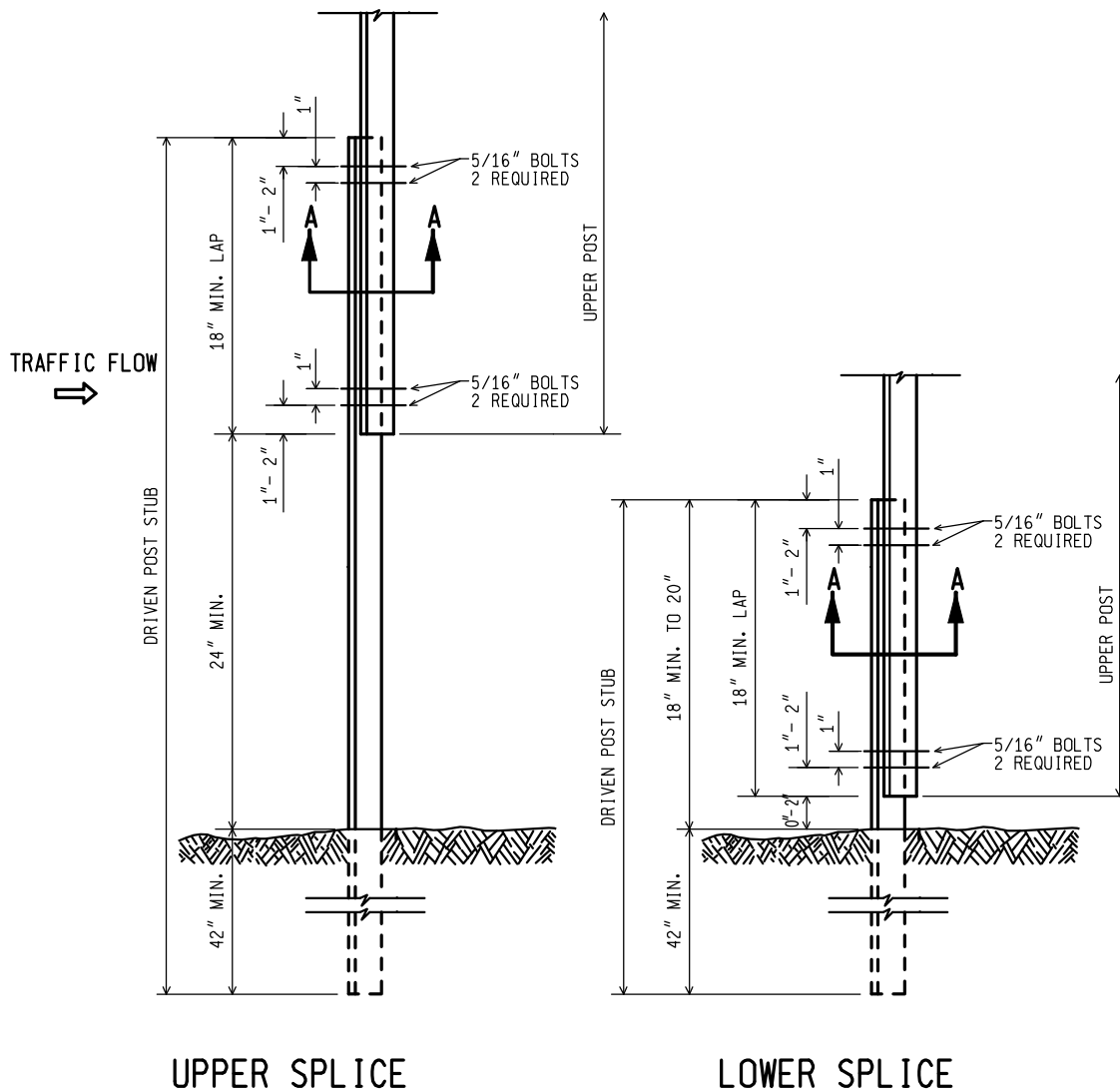

**3 lb. U - CHANNEL STEEL POST  
(WITH SPLICE)**

MOUNT SIGN ON OPEN FACE OF  
UPPER U - CHANNEL STEEL POST

NOT TO SCALE

MICHIGAN DEPARTMENT OF TRANSPORTATION  
BUREAU OF HIGHWAYS DELIVERY STANDARD PLAN

PENDING  
FHWA APPROVAL DATE

8/2006

PLAN DATE

WZD-100-A

SHEET  
5 of 11

File:PW/Doc/RD/T&S/Typ/Dev/Sign MainTraf D/WZD-100-A Rev. 8/21/06 ECH

NOTE: THE ORIGINAL SIGNED COPY IS KEPT ON FILE AT THE MICHIGAN DEPARTMENT OF TRANSPORTATION.

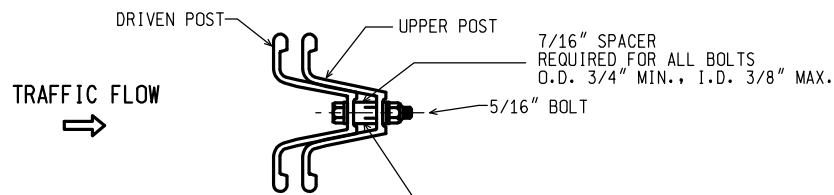

**SECTION A-A**

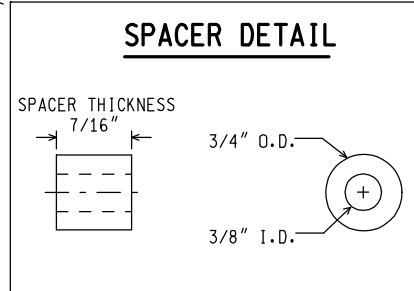

**NOTES:**

1. THE SPACER THICKNESS SHALL BE 1/16" LESS THAN THE GAP BETWEEN THE POST WHEN POSITIONED IN THE UNBOLTED CONFIGURATION.
2. THE EXTERIOR BOLT (CLOSEST TO LAP), SPACER, WASHER, AND NUT SHALL BE INSTALLED IN A PREPUNCHED HOLE 1" TO 2" FROM THE END OF THE LAP.
3. THE INTERIOR BOLT (FARTHEST FROM LAP), SPACER, WASHER, AND NUT SHALL BE INSTALLED IN THE NEXT PREPUNCHED HOLE.
4. THE DRIVEN POST SHALL ALWAYS BE MOUNTED IN FRONT OF THE UPPER POST WITH RESPECT TO THE ADJACENT ONCOMING TRAFFIC, REGARDLESS OF THE DIRECTION THE SIGN IS FACING.
5. THE SPLICE LAP SHALL BE FASTENED BY FOUR-5/16" DIA. GALVANIZED A449 BOLTS (SAE J429 GRADE 5) OR GALVANIZED A325 BOLTS.

**3 lb. U - CHANNEL STEEL POST**  
**(WITH SPLICE)**

NOT TO SCALE

MICHIGAN DEPARTMENT OF TRANSPORTATION BUREAU OF HIGHWAYS DELIVERY STANDARD PLAN	PENDING FHWA APPROVAL DATE	8/2006 PLAN DATE	WZD-100-A	SHEET 6 of 11
File:PW/Doc/RD/T&S/Typ/Dev/Sign MainTraf D/WZD-100-A Rev. 8/21/06 ECH				

NOTE: THE ORIGINAL SIGNED COPY IS KEPT ON FILE AT THE MICHIGAN DEPARTMENT OF TRANSPORTATION.



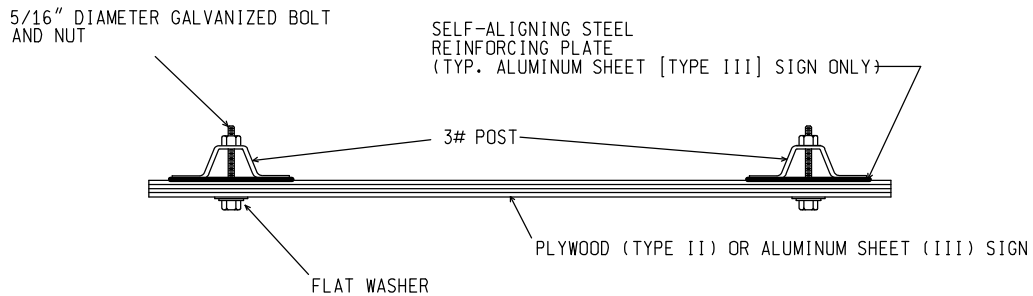

**SIGN TO 3 lb. POST CONNECTION**

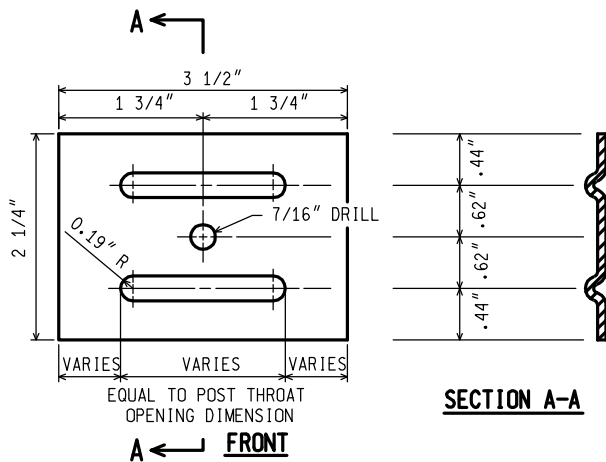

**NOTES: (FOR STEEL SIGN REINF' PLATE)**

1. MATERIAL: 12 GAUGE CARBON STEEL.
2. TOLERANCE ON ALL DIMENSIONS  $\pm 0.0625"$
3. FINISH-AFTER STAMPING AND PUNCHING, GALVANIZE ACCORDING TO CURRENT SPECIFICATIONS FOR ZINC (HOT GALVANIZE) COATINGS ON PRODUCTS FABRICATED FROM PLATES OR STRIPS

**STEEL SIGN REINFORCING PLATE**  
**REQUIRED FOR TYPE III SIGNS ONLY**

**3 lb. U - CHANNEL STEEL POST SIGN CONNECTION**

NOT TO SCALE

MICHIGAN DEPARTMENT OF TRANSPORTATION  
BUREAU OF HIGHWAYS DELIVERY STANDARD PLAN

PENDING  
FHWA APPROVAL DATE

8/2006  
PLAN DATE

WZD-100-A

SHEET  
7 of 11

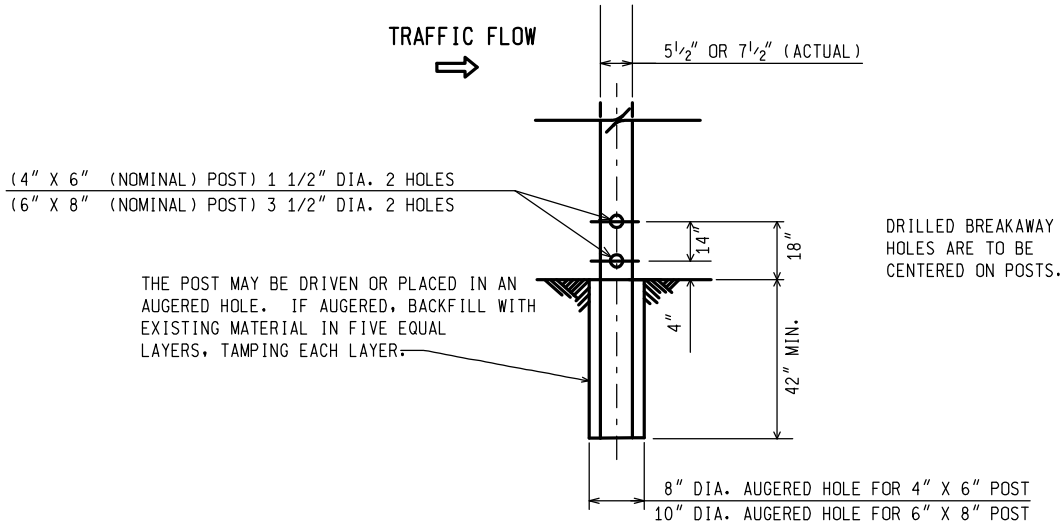

**WOOD POST BREAKAWAY HOLES/  
 DIRECT EMBEDMENT DETAILS**

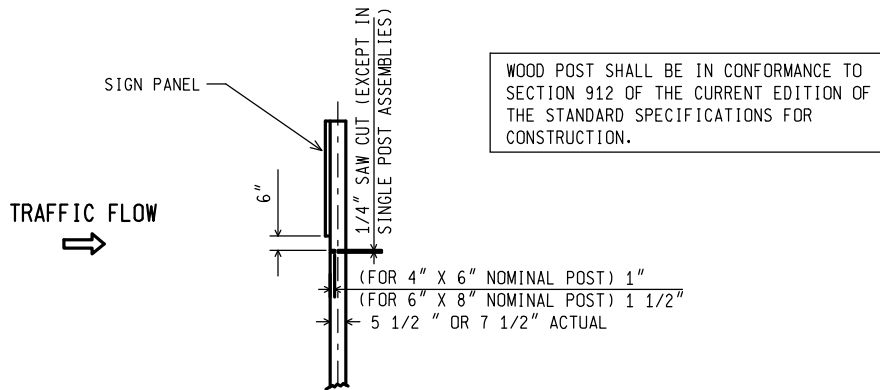

**SAW CUT DETAIL  
 (MULTIPLE POST INSTALLATIONS)**

**WOOD POST DETAILS**

NOT TO SCALE

MICHIGAN DEPARTMENT OF TRANSPORTATION  
 BUREAU OF HIGHWAYS DELIVERY STANDARD PLAN

PENDING  
 FHWA APPROVAL DATE

8/2006  
 PLAN DATE

WZD-100-A

SHEET  
 8 of 11

File:PW/Doc/RD/T&S/Typ/Dev/Sign MainTraf D/WZD-100-A Rev. 8/21/06 ECH

NOTE: THE ORIGINAL SIGNED COPY IS KEPT ON FILE AT THE MICHIGAN DEPARTMENT OF TRANSPORTATION.

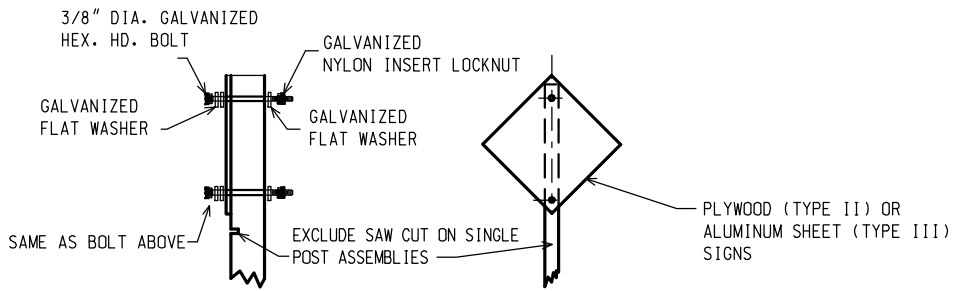

**TYPE II AND TYPE III SIGNS**

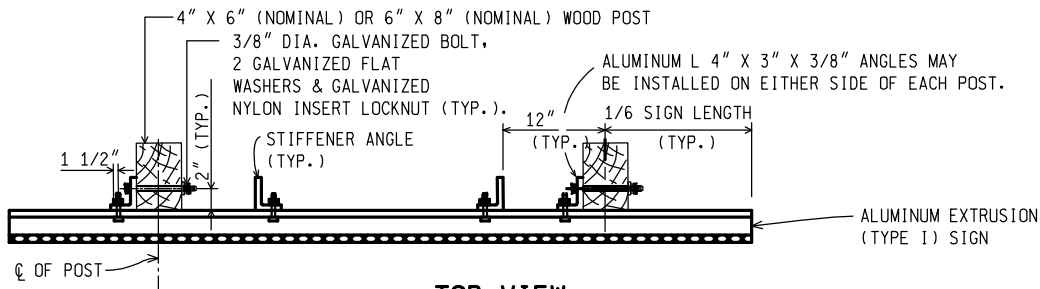

**TOP VIEW  
TYPE I SIGN**

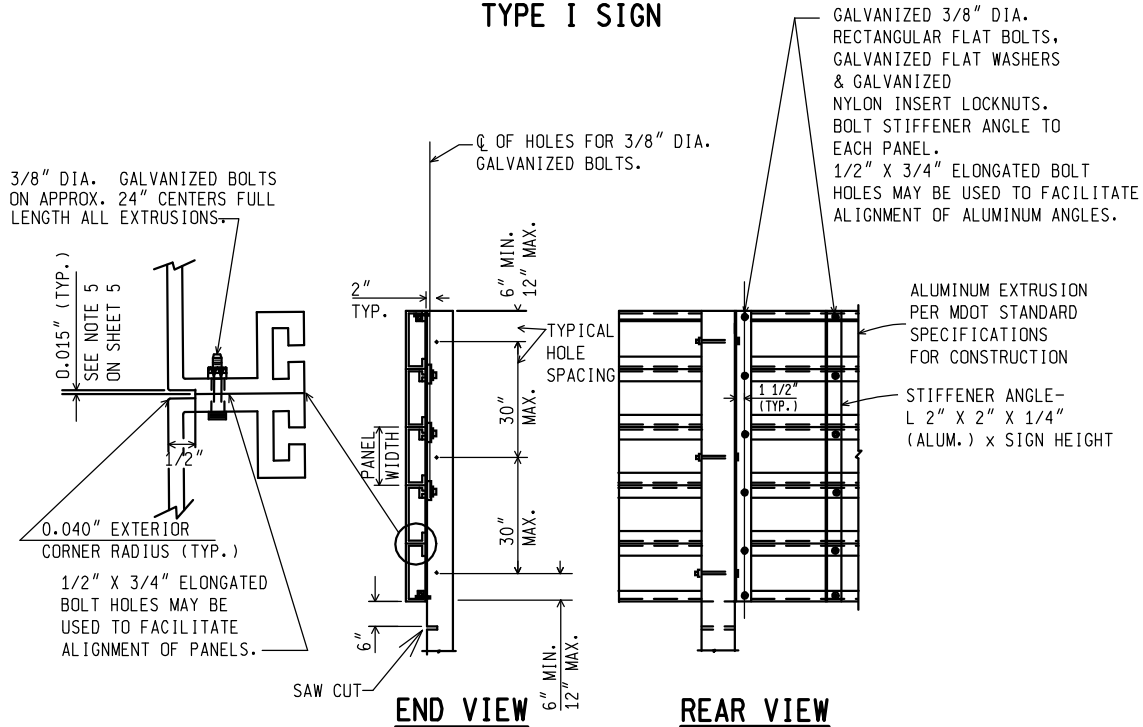

**TYPE I SIGN - ERECTION DETAILS**

**WOOD POST CONNECTIONS**

NOT TO SCALE

MICHIGAN DEPARTMENT OF TRANSPORTATION  
BUREAU OF HIGHWAYS DELIVERY STANDARD PLAN

PENDING  
FHWA APPROVAL DATE

8/2006

WZD-100-A

SHEET  
9 of 11

File:PW/Doc/RD/T&S/Typ/Dev/Sign MainTraf D/WZD-100-A Rev. 8/21/06 ECH

PLAN DATE

NOTE: THE ORIGINAL SIGNED COPY IS KEPT ON FILE AT THE MICHIGAN DEPARTMENT OF TRANSPORTATION.

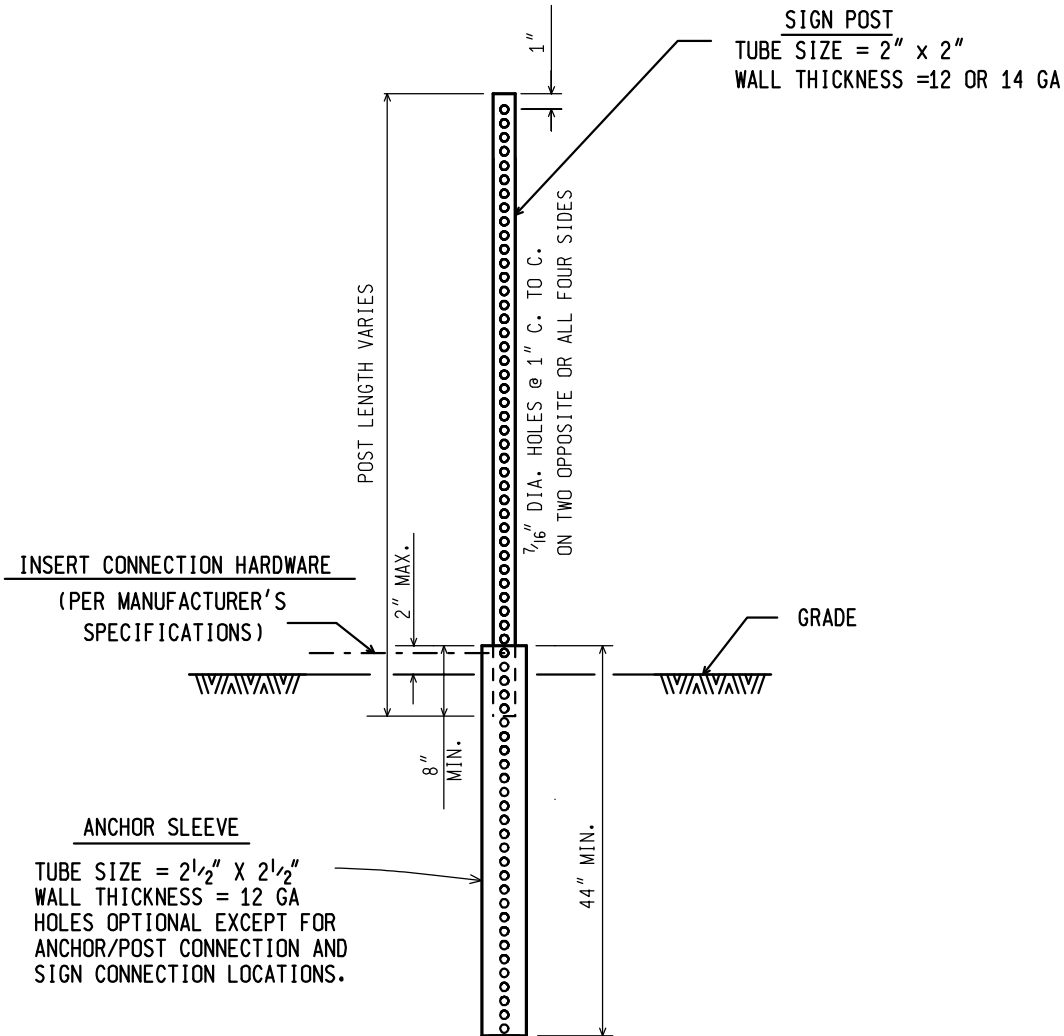

## SQUARE TUBULAR STEEL POST

NOT TO SCALE

MICHIGAN DEPARTMENT OF TRANSPORTATION  
 BUREAU OF HIGHWAYS DELIVERY STANDARD PLAN

PENDING  
 FHWA APPROVAL DATE

8/2006

PLAN DATE

WZD-100-A

SHEET  
 10 of 11

File:PW/Doc/RD/T&S/Typ/Dev/Sign MainTraf D/WZD-100-A Rev. 8/21/06 ECH

NOTE: THE ORIGINAL SIGNED COPY IS KEPT ON FILE AT THE MICHIGAN DEPARTMENT OF TRANSPORTATION.

GENERAL NOTES:

1. A MAXIMUM OF TWO POSTS WITHIN A 7 FOOT PATH IS PERMITTED.
2. ALL SIGN POSTS SHALL COMPLY WITH NCHRP 350.
3. ALL POSTS SHALL BE EMBEDDED A MINIMUM OF 42".
4. BRACING OF POST IS NOT PERMITTED.
5. SIGN SHALL BE LEVEL, AND UPRIGHT FOR THE DURATION OF INSTALLATION.
6. ERECT POSTS SO THE SIGN FACE AND SUPPORTS DO NOT VARY FROM PLUMB BY MORE THAN 3/16" IN 3'. PROVIDE A CENTER-TO-CENTER DISTANCE BETWEEN POSTS WITHIN 2 PERCENT OF PLAN DISTANCE.
7. NO MORE THAN ONE SPLICE PER POST, AS SHOWN, WILL BE PERMITTED.
8. POST TYPES SHALL NOT BE MIXED WITHIN A SIGN SUPPORT INSTALLATION.
9. NO VERTICAL JOINTS ARE PERMITTED IN SIGN. NO HORIZONTAL JOINTS THROUGH SIGN LEGEND OR SYMBOLS ARE PERMITTED IN SIGN
10. REMOVE SIGN POSTS AND/OR POST STUBS IN THEIR ENTIRETY WHEN NO LONGER REQUIRED.
11. ALL LABOR, MATERIALS, AND EQUIPMENT, INCLUDING TEMPORARY SUPPORTS REQUIRED TO INSTALL, MAINTAIN, RELOCATE, COVER, AND/OR REMOVE THE TEMPORARY SIGN, INCLUDING SUPPORTS, ARE CONSIDERED TO BE INCLUDED IN THE COST OF THE TEMPORARY SIGN.
12. SAW CUTS IN WOOD POSTS ARE TO BE PARALLEL TO THE BOTTOM OF THE SIGN.
13. POSTS SHALL NOT EXTEND MORE THAN 4" ABOVE TOP OF SIGN.

NOT TO SCALE

MICHIGAN DEPARTMENT OF TRANSPORTATION BUREAU OF HIGHWAYS DELIVERY STANDARD PLAN	PENDING FHWA APPROVAL DATE	8/2006 PLAN DATE	WZD-100-A	SHEET 11 of 11
File:PW/Doc/RD/T&S/Typ/Dev/Sign MainTraf D/WZD-100-A Rev. 8/21/06 ECH				

NOTE: THE ORIGINAL SIGNED COPY IS KEPT ON FILE AT THE MICHIGAN DEPARTMENT OF TRANSPORTATION.

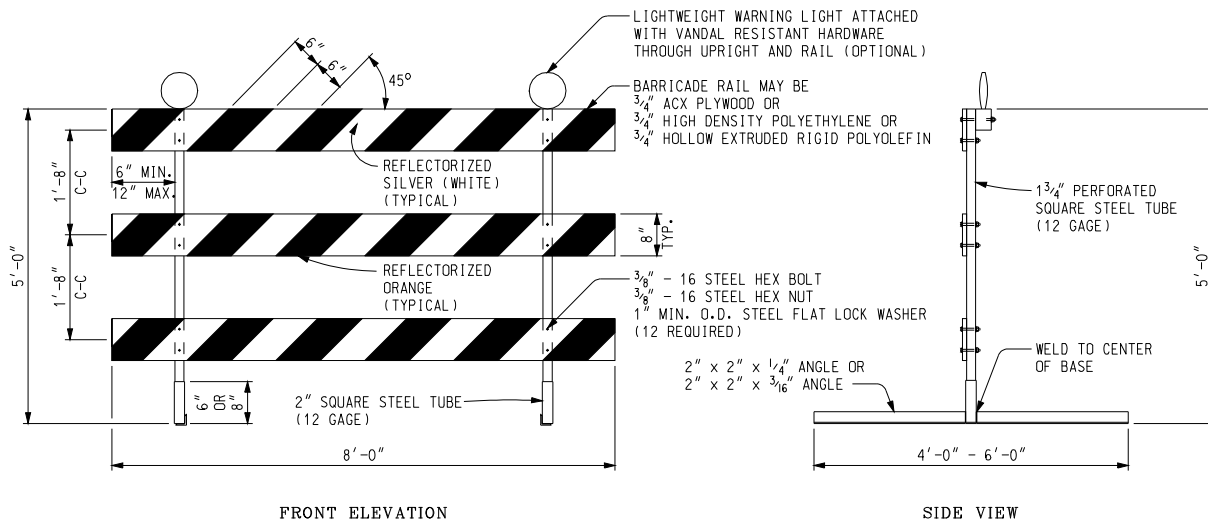

FRONT ELEVATION

SIDE VIEW

PERFORATED SQUARE STEEL TUBE OPTION

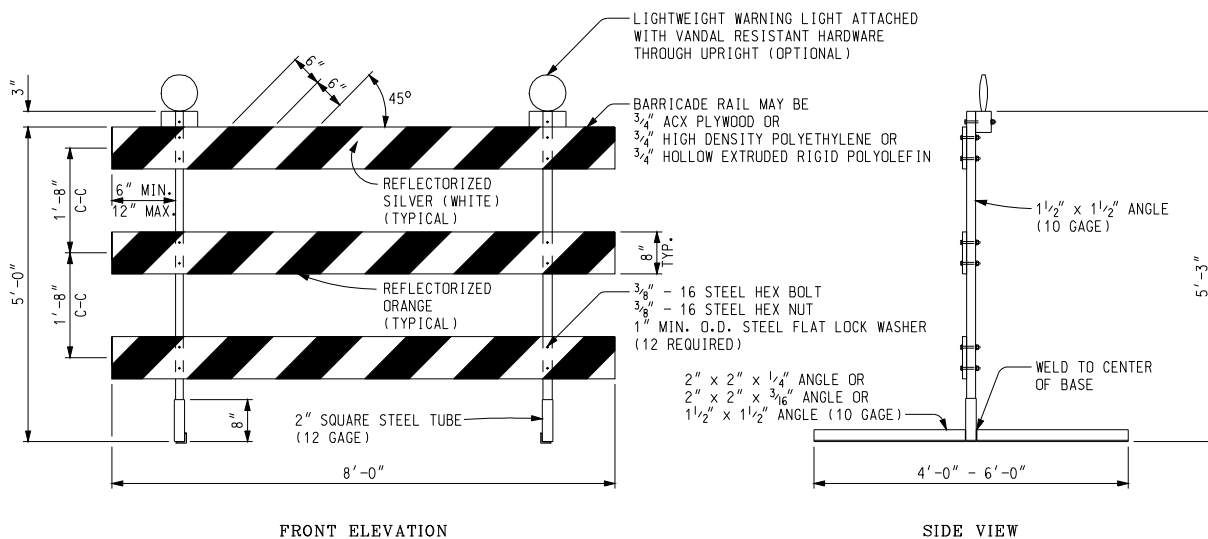

FRONT ELEVATION

SIDE VIEW

ANGLE IRON OPTION

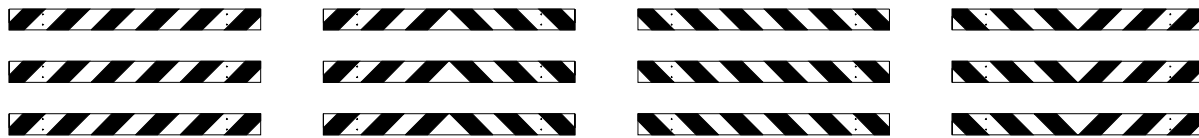

LEFT DIRECTIONAL

BI-DIRECTIONAL

RIGHT DIRECTIONAL

CLOSURES

BARRICADE RAIL SHEETING OPTIONS  
TYPE III BARRICADES

Other Type III Barricades meeting current NCHRP crash worthy criteria can be found on the FHWA Safety website at [http://safety.fhwa.dot.gov/roadway\\_dept/road\\_hardware/wzd.htm](http://safety.fhwa.dot.gov/roadway_dept/road_hardware/wzd.htm)

NOT TO SCALE

File: T&S/Typ/Signs/WorkZones/wzd 125 d

Rev. 09/22/09 PJ



PREPARED BY  
TRAFFIC AND SAFETY

ENGINEER OF DELIVERY

ENGINEER OF DEVELOPMENT

MICHIGAN DEPARTMENT OF TRANSPORTATION  
BUREAU OF HIGHWAYS DELIVERY STANDARD PLAN FOR

Temporary  
Traffic Control Devices

DRAWN BY: ECH

(SPECIAL DETAIL)

9/22/09  
PLAN DATE

WZD-125-E

SHEET  
1 of 3

CHECKED BY: MWB

FHWA APPROVAL DATE

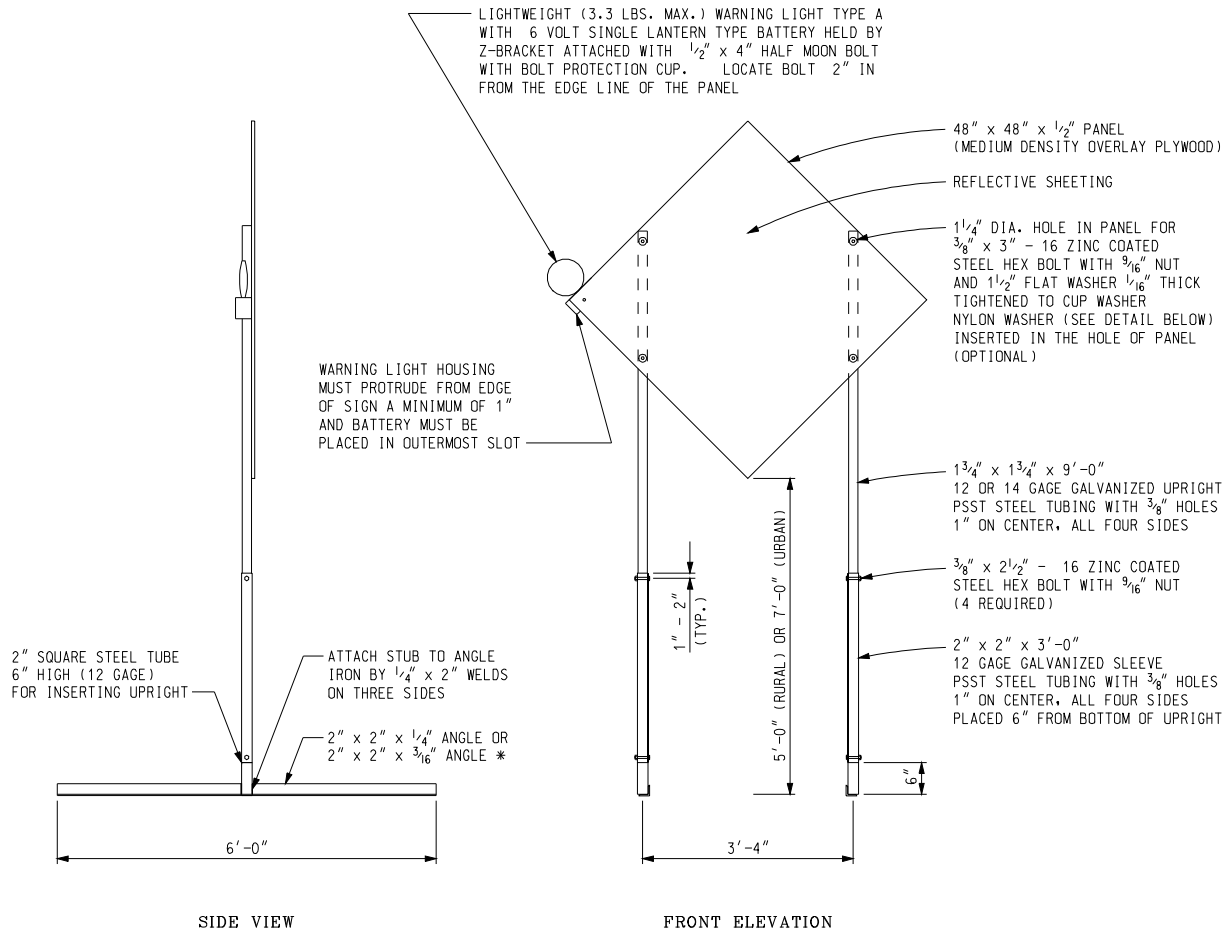

### TEMPORARY SIGN SUPPORT

(WARNING LIGHT PLACED ON SIDE CLOSEST TO TRAFFIC)

\* SIGN STAND IS BALLASTED WITH FOUR OR MORE 35 LB SANDBAGS. A MINIMUM OF ONE ON EACH END.  
 UPRIGHTS SHALL NOT EXTEND ABOVE THE SIGN PANEL.

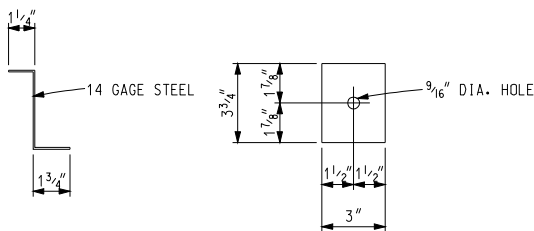

Z-BRACKET DETAIL

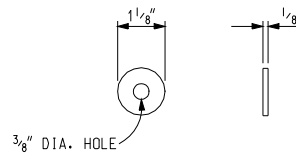

OPTIONAL NYLON WASHER

Other temporary sign supports meeting current NCHRP crash worthy criteria can be found on the FHWA Safety website at [http://safety.fhwa.dot.gov/roadway\\_dept/road\\_hardware/wzd.htm](http://safety.fhwa.dot.gov/roadway_dept/road_hardware/wzd.htm)

NOT TO SCALE

MICHIGAN DEPARTMENT OF TRANSPORTATION  
 BUREAU OF HIGHWAYS DELIVERY STANDARD PLAN

(SPECIAL DETAIL)  
 FHWA APPROVAL DATE

9/22/09  
 PLAN DATE

WZD-125-E

SHEET  
 2 of 3

File: T&S/Typ/Signs/WorkZones/wzd 125 d

Rev. 09/22/09 PJ

NOTE: THE ORIGINAL SIGNED COPY IS KEPT ON FILE AT THE MICHIGAN DEPARTMENT OF TRANSPORTATION.

- PLASTIC DRUM
- ▲▲▲ PROPOSED TYPE III BARRICADE
- △△△ EXISTING TYPE III BARRICADE

SYMBOLS TO BE USED ON PLANS

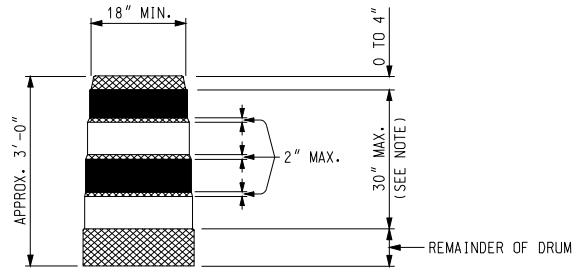

- REFLECTORIZED ORANGE
- REFLECTORIZED WHITE
- NON REFLECTORIZED ORANGE

NOTE:  
 DRUMS SHALL HAVE AT LEAST 4 HORIZONTAL REFLECTORIZED STRIPES (2 ORANGE AND 2 WHITE) OF 6" UNIFORM WIDTH, ALTERNATING IN COLOR WITH THE TOPMOST REFLECTORIZED STRIPE BEING ORANGE. NON REFLECTORIZED SPACES BETWEEN THE HORIZONTAL REFLECTORIZED ORANGE AND WHITE STRIPES SHALL BE ORANGE IN COLOR AND EQUAL IN WIDTH.

PLASTIC DRUM

NOTES:

2" PERFORATED SQUARE STEEL TUBES MAY BE USED TO FABRICATE THE HORIZONTAL BASE OF THE TYPE III BARRICADE.

WARNING LIGHTS SHALL BE PLACED ACCORDING TO THE CURRENT STANDARD SPECIFICATIONS FOR CONSTRUCTION AND ALL OTHER PROVISIONS IN THE CONTRACT WHEN THEY ARE USED ON TYPE III BARRICADES.

SEE ROAD STANDARD PLANS R-113-SERIES FOR TEMPORARY CROSOVERS FOR DIVIDED ROADWAY, AND R-126-SERIES FOR TYPICAL LOCATION AND SPACING OF PLASTIC DRUMS FOR PLACEMENT OF TEMPORARY CONCRETE BARRIER.

SIGNS, BARRICADES, AND PLASTIC DRUMS SHALL BE FACED WITH PRESSURE-SENSITIVE REFLECTIVE SHEETING ACCORDING TO THE CURRENT STANDARD SPECIFICATIONS FOR CONSTRUCTION.

SANDBAGS SHALL BE USED WHEN SUPPLEMENTAL WEIGHTS ARE REQUIRED TO ACHIEVE STABILITY OF THE BARRICADE. THE SANDBAGS SHALL BE PLACED SO THEY WILL NOT COVER OR OBSTRUCT ANY REFLECTIVE PORTION OF THE TRAFFIC CONTROL DEVICE.

NOT TO SCALE

MICHIGAN DEPARTMENT OF TRANSPORTATION BUREAU OF HIGHWAYS DELIVERY STANDARD PLAN	(SPECIAL DETAIL) FHWA APPROVAL DATE	9/22/09	WZD-125-E	SHEET 3 of 3
File: T&S/Typ/Signs/WorkZones/wzd 125 d	Rev. 09/22/09 PJ	PLAN DATE		

NOTE: THE ORIGINAL SIGNED COPY IS KEPT ON FILE AT THE MICHIGAN DEPARTMENT OF TRANSPORTATION.



MICHIGAN  
DEPARTMENT OF TRANSPORTATION  
SPECIAL PROVISION  
FOR  
**INSURANCE**

CSD:JDM

1 of 1

APPR:KF:DBP:09-17-14

**Add the following after the first paragraph in subsection 107.10.C.4, on page 60 of the Standard Specifications for Construction:**

In addition to the above insurance requirements, the following agencies must be listed as additional insured:

The agencies are the: Allegan County and the Allegan County Road Commission.

**ALLEGAN COUNTY ROAD COMMISSION**

**SPECIAL PROVISION**

**FOR**

**HMA APPLICATION ESTIMATE**

1 of 1

WAI/AJN

08/07/2014

**a. Description.** Perform this work in accordance with the requirements of Division 5 of the MDOT 2012 Standard Specifications for Construction, except as herein specified.

**b. Materials.**

Hand Patching shall be HMA, 13A. Application rate is variable.  
To be used on inlet ends of culvert downspout pipes.

The Asphalt performance grade shall be PG 58-28.

Bond Coat shall be SS-1h Bond Coat applied at the rate of 0.05 to 0.15 gallons/SYD to be included in the respective HMA mixture items.

Reclaimed Asphalt Pavement (RAP) shall be restricted to Tier 1 limits for all mix designs.

**c. Construction Methods.** Complete this work in accordance with Section 501.03 of the MDOT 2012 Standard Specifications for Construction.

**d. Measurement and Payment.** Measurement and Payment will be at the contract unit price per ton. The Contractor shall be responsible for the control of the HMA application rates for this project. The pay quantity for HMA mixtures on this project shall not exceed more than 5% of the calculated quantities for each course, except **Hand Patching**, based upon the above referenced yields and the actual areas paved. Quantities in excess of the above will not be considered for payment.

MICHIGAN  
DEPARTMENT OF TRANSPORTATION

SPECIAL PROVISION  
FOR  
**SLOPE RESTORATION, NON-FREEWAY**

C&amp;T:DMG

1 of 3

C&amp;T:APPR:TWK:DBP:04-25-12

**a. Description.** This work consists of preparing all lawns and slopes on non-freeway projects designated for slope restoration on the plans or as directed by the Engineer and applying topsoil, fertilizer, seed, mulch with mulch anchor, mulch blanket, high velocity mulch blanket and permanent turf reinforcement mat to those areas. Turf establishment must be in accordance with section 816 of the Standard Specifications for Construction and Standard Plan R-100 Series, except as modified herein or otherwise directed by the Engineer.

**b. Materials.** The materials and application rates specified in sections 816 and 917 of the Standard Specifications for Construction apply unless modified by this special provision or otherwise directed by the Engineer. The following materials must be used on this project:

1. Seeding mixture as called for on the plans
2. Fertilizer, Chemical Nutrient, Class A
3. Topsoil Surface, Furnished or Salvaged, 4 inch. Remove any stones greater than 1/2 inch in diameter or other debris from all topsoil.
4. Mulch and Mulch Anchoring, Mulch Blanket and High Velocity Mulch Blanket
5. Permanent Turf Reinforcement Mat (TRM) must be 100 percent synthetic and consist of 100 percent ultraviolet (UV) stabilized polyolefin fibers sewn between two layers of black UV stabilized polypropylene netting with polyolefin thread. The TRM must meet the following "minimum average roll value" requirements:

<b>Property</b>	<b>Test Method</b>	<b>Requirement</b>
Mass/Unit Area	ASTM D 6566	10 oz/syd
Ultraviolet Stability @ 1000 hrs	ASTM D 4355	80 percent
Tensile Strength (MD)	ASTM D 6818	165 lbs/ft

Acceptance. Supply a Test Data Certification for the permanent TRM from one of the following manufacturers:

Recyclex - American Excelsior Co., Arlington, TX (800) 777-7645  
P300 - North American Green, Poseyville, IN (800) 772-2040  
Landlok 450 - Propex, Inc., Chattanooga, TN (800) 621-1273  
PP5-10 - Western Excelsior, Mancos, CO (800) 833-8573

**c. Construction.** Construction methods must be in accordance with subsection 816.03 of the Standard Specifications for Construction. Begin this work as soon as possible after final grading of the areas designated for slope restoration but no later than the maximum time frames stated in

subsection 208.03 of the Standard Specifications for Construction. It may be necessary, as directed by the Engineer, to place materials by hand.

Shape, compact and assure all areas to be seeded are weed free prior to placing topsoil. Place topsoil to the minimum depth indicated above, to meet proposed finished grade. If the area being restored requires more than the minimum depth of topsoil to meet finished grade, this additional depth must be filled using topsoil or, at the Contractor's option, embankment. Furnishing and placing this additional material is included in this item of work.

Topsoil must be weed and weed seed free and friable prior to placing seed. Remove any stones greater than 1/2 inch in diameter or other debris. Apply seed mixture and fertilizer to prepared soil surface. Incorporate seed into top 1/2 inch of topsoil

Apply mulch at a rate of 2 tons per acre. Place Mulch Anchoring over the mulch at a rate specified in subsection 816.03.F of the Standard Specifications for Construction. Mulch Blanket and High Velocity Mulch Blanket must be placed in accordance with subsection 816.03.H of the Standard Specifications for Construction and as shown on Standard Plan R-100 Series.

Areas constructed with the TRM must be installed on prepared (seeded) grades as shown on the plans in strict accordance with the manufacturer's published installation guidelines. The top edge of the TRM must be anchored in a minimum 6 inch deep trench. Operation of equipment on the slope will not be allowed after placement of the TRM. No credit for splices, overlaps, tucks or wasted material will be made.

If an area washes out after this work has been properly completed and approved by the Engineer, make the required corrections to prevent future washouts and replace the topsoil, fertilizer, seed and mulch. This replacement will be paid for as additional work using the applicable contract items.

If an area washes out for reasons attributable to the Contractor's activity or failure to take proper precautions, replacement will be at the Contractor's expense.

The Engineer will inspect the seeded turf to ensure the end product is well established, weed free, in a vigorous growing condition, and contains the species called for in the seeding mixture.

If the seeded turf is not well established at the end of the first growing season, the Contractor is responsible to re-seed until the turf is well established and approved by the Engineer.

If weeds are determined by the Engineer to cover more than 10 percent of the total area of slope restoration, the Contractor must provide weed control in accordance with subsection 816.03.J of the Standard Specifications for Construction. Weed control will be at the Contractor's expense with no additional charges to the project.

**d. Measurement and Payment.** The completed work, as described, will be measured and paid for at the contract unit price using the following pay item:

<b>Pay Item</b>	<b>Pay Unit</b>
Slope Restoration, Type _____	Square Yard

1. Place **Slope Restoration, Type A** in all areas not described in the other types of slope restoration and will be measured by area in square yards in place. **Slope Restoration, Type A**

includes all labor, equipment and materials required to install Topsoil Surface, Furnished or Salvaged; Fertilizer, Chemical Nutrient, Class A; Seeding Mixture; and Mulch and Mulch Anchoring which will not be paid for separately but is included in the contract unit price for **Slope Restoration, Type A**.

2. Place **Slope Restoration, Type B** parallel (6 feet minimum) to the edge of the roadway, in areas that have a 1 on 3 slope and in any ditch with a grade less than 1.5 percent, or as directed by the Engineer. **Slope Restoration, Type B** will be measured by area in square yards in place. **Slope Restoration, Type B** includes all labor, equipment and materials required to install Topsoil Surface, Furnished or Salvaged; Fertilizer, Chemical Nutrient, Class A; Seeding Mixture; and Mulch Blanket which will not be paid for separately but is included in the contract unit price for **Slope Restoration, Type B**.

3. Place **Slope Restoration, Type C** in areas that have a 1 on 2 slope, any ditch with a grade of 1.5 percent to 3 percent or as directed by the Engineer. **Slope Restoration, Type C** will be measured by area in square yards in place. **Slope Restoration, Type C** includes all labor, equipment and materials required to install Topsoil, Furnished or Salvaged; Fertilizer, Chemical Nutrient, Class A; Seeding Mixture; and High Velocity Mulch Blanket which will not be paid for separately but is included in the contract unit price for **Slope Restoration, Type C**.

4. Place **Slope Restoration, Type D** in areas that have a slope steeper than 1 on 2, any ditch with a grade steeper than 3 percent or as directed by the Engineer. **Slope Restoration, Type D** will be measured by area in square yards in place. **Slope Restoration, Type D** includes all labor, equipment and materials required to install Topsoil, Furnished or Salvaged; Fertilizer, Chemical Nutrient, Class A; Seeding Mixture; and TRM which will not be paid for separately but is included in the contract unit price for **Slope Restoration, Type D**.

MICHIGAN  
DEPARTMENT OF TRANSPORTATION  
  
SPECIAL PROVISION  
FOR  
**CONTRACTOR PERFORMANCE EVALUATIONS**

C&amp;T:JJG

1 of 2

C&T:APPR:BJO:RRV:06-07-11  
FHWA:APPR:06-20-11

**a. Description.** Project management staff will evaluate the Contractor's performance on this project and the evaluation may be used as a basis for modifying the prequalification ratings of the Contractor. An evaluation may be issued during the course of a project (interim) and will be issued after completion of a project (final). The criteria used for the evaluation will be provided by the Engineer upon written request at the preconstruction meeting or found on the MDOT web site in the Bureau of Highways Instructional Memorandum 2011-01. Any action to modify the Contractor's prequalification ratings will be taken in accordance with the duly promulgated prequalification rules.

If an interim contractor performance evaluation is issued and regardless of whether the Contractor requests a meeting to discuss a Contractor Performance Evaluation, project management staff may require the Contractor to submit a performance improvement plan to address needs identified in the Contractor Performance Evaluation and to attend a meeting to discuss the improvement plan. After the meeting is held, the project management staff may approve the plan or require changes to the plan. Resubmit the plan if changes are required. Immediately implement approved performance improvement plans. If the Contractor does not implement the plan immediately, MDOT will consider the Contractor to be in non-compliance and will take action as described under section c of this special provision.

Within 21 days of the receipt of a Contractor Performance Evaluation, the Contractor may make a written request to meet with project management staff to review the evaluation. As a result of this meeting, the evaluation may be left unchanged or revised as deemed appropriate by the Engineer. The Engineer will then give the Contractor written notice with the final Contractor Performance Evaluation. If the meeting is not requested within the 21-day period, the original evaluation becomes the final and will not be subject to later contest or appeal.

**b. Appeals.**

1. Appeal of Evaluation. Within 14 days after the date a performance evaluation becomes final and is received by a Contractor, they may file a written appeal of any rating of seven or below to the Engineer. The written appeal must contain documentation supporting the Contractor's position that the rating is not warranted. The appeal will be considered by a Contractor Performance Evaluation Appeal Panel. If no appeal is filed within the 14-day period, the evaluation becomes final and will not be subject to later contest or appeal. Interim Contractor Performance Evaluations cannot be appealed.

2. Appeal of Performance Improvement Plan. Within 14 days after the date that a performance improvement plan is approved and sent to the Contractor, the Contractor may file a written appeal of that plan to the Engineer and request to appear before a Performance Evaluation Appeal Panel. Documentation must include the reasons for the appeal. If a timely written appeal is not filed, the performance improvement plan becomes final and will not be

subject to later contest or appeal.

An appeal filed by a Contractor will be considered by a Contractor Performance Evaluation Appeal Panel. The panel will be composed of three licensed professional Engineers from the Department (following the format of a Central Office Review Panel) who were not directly involved in the management of the project. This panel will review appeals on all Contractor Performance Evaluations for this project. The Contractor and the Engineer will be required to submit supporting documentation relevant to the appeal and will attend a formal appeal hearing. Upon concluding its review, the panel will confirm or modify the Contractor Performance Evaluation. The panel will, within 30 days, send the Contractor and Engineer written notice of its decision along with a copy of the modified Contractor Performance Evaluation if applicable. The original or modified Contractor Performance Evaluation is final and constitutes the Department's decision; it is not subject to further contest or appeal.

**c. Non-Compliance.** If a Contractor fails to honor a request by project management staff to submit a performance improvement plan or to meet to discuss it, or if a Contractor fails to carry out an approved performance improvement plan, that failure may be used as a basis for modifying the prequalification ratings of the Contractor. Any action to modify the Contractor's prequalification ratings will be taken in accordance with the duly promulgated prequalification rules.

**d. Subcontractors.** For purposes of this special provision, the word "Contractor" includes subcontractors. Project management staff will evaluate the performance of subcontractors in accordance with this special provision.

MICHIGAN  
DEPARTMENT OF TRANSPORTATION

SPECIAL PROVISION  
FOR  
**ELECTRONIC TRANSMITTAL OF CONTRACT DOCUMENTS**

CSD:JDM

1 of 1

APPR:JC:DBP:10-26-12  
FHWA:APPR:11-08-12

**Delete the first sentence in subsection 102.15, on page 22 of the Standard Specifications for Construction, and replace with the following:**

The Department will provide the contract and bond forms electronically to the determined low Bidder, using Bid Express. The low Bidder will receive notification of the documents availability at the e-mail address associated with that account. The determined low Bidder will be responsible for printing the contract documents for return to the Department.



MICHIGAN  
DEPARTMENT OF TRANSPORTATION

SPECIAL PROVISION  
FOR  
**LOW BID WITHDRAWAL PRIOR TO CONTRACT AWARD**

CSD:JDM

1 of 1

APPR:JJG:DBP:07-02-13  
FHWA:APPR:07-10-13

**Add the following sentence to the end of the last paragraph in subsection 102.17, on page 24 of the Standard Specifications for Construction:**

A determined low bidder whose bid is withdrawn prior to contract award cannot participate as a subcontractor, supplier, or trucker on the project.

**Add the following sentence to the end of the fifth paragraph in subsection 108.01. on page 72 of the Standard Specifications for Construction:**

The Contractor may not hire, a determined low bidder on a project who has withdrawn a bid prior to award, as a subcontractor, supplier, or trucker on the same project.

MICHIGAN  
DEPARTMENT OF TRANSPORTATION

SPECIAL PROVISION  
FOR  
**JOINT/TWO-PARTY CHECKS**

CSD:JDM

1 of 1

APPR:JAT:DBP:07-01-14  
FHWA:APPR:07-11-14

**a. Description.** This special provision establishes the requirements for participants desiring a joint/two-party check arrangement.

**b. Requirements.** Participants desiring a joint/two-party check arrangement must submit an *Application to Use Joint Checks* (MDOT Form 0183) to the MDOT as described on the Form 0183. An acceptable joint check arrangement must include the following:

1. Prime contractor/payor cannot require the subcontractor to use a specific supplier or the prime contractor's negotiated price;
2. Subcontractor is more than an extra participant in releasing the check to the material supplier;
3. Subcontractor negotiates the quantities, price and deliver of materials;
4. Prime contractor/payor issuing the check acts solely as guarantor;
5. Subcontractor releases the check to the supplier;
6. Only a short term arrangement (no more than two seasons) with the purpose being establishment of or increase of subcontractor's credit line with the material supplier; and
7. Subcontractor is responsible to both furnish and install the material/work item.

Copies of cancelled joint checks issued from the prime/payor to a DBE and supplier must be submitted by mail, fax, or e-mail to the MDOT Office of Business Development upon request.

**c. Measurement and Payment.** Joint/Two-Party Checks arrangements will not be paid for separately, but will be included in costs for other pay items.

MICHIGAN  
DEPARTMENT OF TRANSPORTATION

SPECIAL PROVISION  
FOR  
**DISSEMINATION OF PUBLIC RELATIONS INFORMATION**

CSD:JDM

1 of 1

APPR:JAT:DBP:07-01-14  
FHWA:APPR:07-08-14

**a. Description.** This special provision establishes the requirements for dissemination of any public relations communications and/or products intended for an external audience pertaining to this contract. Dissemination must not be made without prior written approval from the Department, Office of Communications, and then only in accordance with explicit instructions by the Department. This includes the use of the Michigan Department of Transportation (MDOT) logo.

A violation of this provision may be considered a default of contract and the Department may exercise its rights in accordance with subsection 108.11 of the Standard Specifications for Construction.

**b. Public Relations Information.** Examples of communications and/or products may include, but are not limited to: brochures, flyers, invitations, programs, postings on social media sites or web sites, new or updated video, digital versatile disk (DVD) productions, or video sharing productions, exhibits, presentations, or any other printed materials intended for an external audience.

MICHIGAN  
DEPARTMENT OF TRANSPORTATION

SPECIAL PROVISION  
FOR  
**DEBRIS OR MATERIALS IN TRAFFIC LANES**

C&amp;T:BRZ

1 of 1

C&T:APPR:EMB:DAJ:01-10-08  
FHWA:APPR:06-01-11

**Delete Subsection 104.07.B.2 on page 36 of the Standard Specifications for Construction, in its entirety and replace it with the following:**

**2. Construction Safety Program.** Before beginning work on the project, the Contractor must submit a written "Construction Safety Program" that outlines the plan and procedures for preventing and mitigating accidents and fires on the project and meeting all health and safety requirements of the contract. Also in the program include provisions for meeting the requirements of subsection 812.03 and details for the materials and equipment that will be used to prevent construction related debris or materials from entering the open lanes of traffic and what actions, including traffic control measures, will be taken to immediately and safely remove the debris or material from the roadway. The Contractor must meet with the Engineer to discuss the "Construction Safety Program" and to develop mutual understandings to govern the administration and enforcement of the program.

**Replace the second sentence in the first paragraph of Subsection 104.07.C.3 on page 37 of the Standard Specifications for Construction with the following:**

The Contractor is responsible, at the Contractor's expense, to provide the necessary materials and equipment to prevent construction related debris or materials from entering the open lanes of traffic. This includes protection of traffic controls, removal of spilled materials or debris from the roadbed or drainage courses, and repair of damaged facilities necessary for public travel and safety.

MICHIGAN  
DEPARTMENT OF TRANSPORTATION

SPECIAL PROVISION  
FOR  
**HIGH VISIBILITY CLOTHING**

SSA:JDG

1 of 1

APPR:MWB:CRB:06-18-14  
FHWA:APPR:06-27-14

**Add the following, to the end, of subsection 104.07.B, Safety and Health Requirements, on page 36 of the Standard Specification for Construction:**

4. **Worker Visibility.** Effective November 24, 2008, all workers within the right-of-way who are exposed to traffic or to construction equipment within the work area, must wear high visibility clothing.

High visibility clothing or high visibility safety apparel is personal protective safety clothing that is intended to provide conspicuity during both daytime and nighttime usage. High Visibility safety apparel must meet the Performance Class 2 or 3 requirements of the American National Standards Institute/International Safety Equipment Association (ANSI/ISEA) 107-2004 for High-Visibility Safety Apparel and subsequent revisions thereof.

Costs incurred to comply with this requirement will be the responsibility of the Contractor.

MICHIGAN  
DEPARTMENT OF TRANSPORTATION  
  
SPECIAL PROVISION  
FOR  
**VALUE ENGINEERING CHANGE PROPOSAL (VECP)**

C&amp;T:EMB

1 of 4

C&T:APPR:SJP:DBP:03-17-10  
FHWA:APPR:06-01-11

**a. Description.** A Value Engineering Change Proposal (VECP) modifying plans, specifications, or other contract requirements may be submitted for this project if the proposed change results in reduced construction cost, a higher quality product, improved safety, or a shorter contract time. The estimated cost savings must be quantifiable in relation to the contract cost. No work can begin before written authorization. The proposed change must not alter the essential functions or characteristics of the project or significantly delay the completion of the project. A VECP or conceptual VECP will only be considered after project award. Essential functions and characteristics include, but are not limited to, service life, operating costs, ease of maintenance, desired appearance, impact on utilities and right of way, mobility and safety of the motorist, bicyclist and pedestrian; design standards, and safety standards. This specification does not restrict the Contractor from proposing improvements to the project that may not result in net cost savings. A conceptual VECP stating the basic concept and approximate cost savings may be submitted for preliminary consideration.

**b. Submittal of Conceptual VECP.** Submit a Conceptual Proposal for the preliminary evaluation. Upon review by the Engineer, one of the following actions will be taken:

- Conceptual approval and a request for the Contractor to submit a formal VECP.
- Request for additional information.
- Denial of the VECP.

Preliminary review of a conceptual proposal reduces the Contractor risk of subsequent denial but does not commit the Department to eventual approval of the full VECP. Submit five copies of the following information for each Conceptual VECP using the Value Engineering Change Proposal Form (Form # 1962) marked Conceptual VECP.

1. A description of the difference between the existing contract items and the proposed changes, and expected benefits.
2. A set of conceptual plans and a description of proposed changes to the contract items.
3. An estimate of the anticipated cost savings or increase.
4. A date by which the Department must make a decision to avoid delays to the existing contract and obtain the cost savings. Also include information on the amount of time necessary to develop the full proposal and impacts to the progress schedule.
5. If impacting maintenance of traffic provisions, identify proposed changes and impacts to the Special Provision for Maintaining Traffic.

After approval of conceptual VECP, the Contractor must follow section c for the Final VECP.

**c. Submittal of Final VECP.** Submit five copies of the following information for each VECP using Value Engineering Change Proposal Form (Form # 1962) marked Final VECP.

1. A description of the difference between the existing contract and the proposed change, and the advantages and disadvantages of each, including effects on service life, operating costs, ease of maintenance, desired appearance, impact on utilities and right of way, mobility and safety of the motorist, bicyclist and pedestrian; design standards, and safety standards.

2. A complete set of plans, if necessary, and specifications showing the revisions relative to the original contract. This portion of the submittal must include design notes and construction details. If the proposal has plans, these must be signed and sealed by the Contractor's Professional Engineer licensed in the State of Michigan.

3. All costs and proposed unit prices must be documented by the Contractor and must include a cost comparison summarizing all the items the VECP replaces, reduces, eliminates, adds, or otherwise changes from the original contract on a spreadsheet.

4. A date by which the Department must make a decision to avoid delays to the existing contract and to obtain the proposed cost savings.

5. If impacting maintenance of traffic provisions, identify proposed changes and impacts to the Special Provision for Maintaining Traffic. If the submitted revisions to the maintaining traffic provision are approved and require any corrections, the Contractor is responsible for all additional costs related to corrective measures.

6. A statement detailing the affect the proposal will have on the time for completing the contract and impacts to the critical path and progress schedule.

7. A description of any known uses or testing of the proposed changes and the conditions and the results.

8. If the VECP submittal includes pay items associated with a warranty, include the latest version of the warranty specification.

**d. Evaluation.** By submitting the VECP, the Contractor agrees not to hold the Department liable for its decision or for any delays to the work attributable to the VECP. Decisions on VECP are not subject to appeal. Work on the project will continue in accordance with the requirements of the contract until a work order is issued which incorporates the VECP changes. The Department has final authority of the acceptability of a VECP and of the estimated net savings attributable to the adoption of all or any part of the VECP. If, in the judgment of the Engineer, contract prices do not represent a fair measure of the value of work to be performed or to be deleted, the Engineer will use other means to determine the estimated net savings.

The Department may modify a VECP, with the concurrence of the Contractor, in order to make it acceptable. The Contractor's share of the savings will be based on the modified VECP.

If the VECP is accepted, in whole or in part, the written acceptance will be issued by a work order and followed with a contract modification. The work order and contract modification will include the necessary changes in the plans and specifications and any conditions upon which the approval is based. Acceptance of the VECP will not extend the time of contract completion unless specifically provided for in the work order and contract modification.

VECP will be evaluated in accordance with the following:

1. The Engineer will determine if a VECP qualifies for consideration and evaluation. The Engineer may deny any VECP that requires excessive time or costs for review, evaluation or investigation. The Engineer may deny any VECP that is not consistent with the Department's design policies and criteria for the project.

2. The Department will not accept a VECP that is similar to a change in the plans or specifications under consideration by the Department for the project at the time the proposal is submitted; nor will the Department accept a proposal based upon, or similar to, standard specifications, general use special provisions or standard drawings adopted by the Department after the advertisement for the contract. The Department reserves the right to make such changes without compensation to the Contractor under the provisions of subsection 103.02 of the Standard Specifications for Construction.

3. The Contractor will have no claim against the Department for additional costs or delays resulting from denial or untimely acceptance of a VECP. These costs include but are not limited to: development costs, loss of anticipated profits, increased material or labor costs, or untimely response.

4. A VECP will be denied if equivalent options are already provided in the contract.

5. A saving resulting solely from the elimination or reduction in quantity of a contract pay item will not be considered as a VECP. A saving resulting from the elimination or reduction in quantity of a contract item specified as part of a VECP may be considered.

6. In calculating the value of cost savings, the Department has the right to disregard the Contract bid prices, if such prices do not represent the value of the work to be performed or to be deleted, and has the right to calculate the savings based on reasonable cost for such work.

7. A VECP cannot be used to alter incentive and disincentive rates and maximum payments on A + B and/or lane rental projects.

8. A VECP will be denied if the design consultant for the contractor is also the design consultant for the Department or other apparent conflicts of interest exist.

**e. Time Frame for VECP Evaluation.** The Contractor will be notified of the Department's decision to approve or deny a conceptual or final VECP within 14 calendar days of receipt of the VECP. If a written acceptance has not been received within this time frame, and the date has not been extended by mutual agreement of both parties, the VECP is denied. The Department's decision is final and there is no appeal.

**f. Future Use of VECP.** The Department reserves the right to use all or any part of a VECP on other contracts without obligation or compensation to the Contractor. If the VECP is



accepted, the Department may use or disclose any information necessary to incorporate the VECP on future projects.

**g. Payment for Work under the VECP.** The Engineer may reject all or any portion of work performed under an approved VECP if results are unsatisfactory. The Engineer will direct the removal of rejected work and construction will proceed under the original contract requirements. There will be no payment for work performed under the proposal, or for its removal.

No work related to a VECP will be performed under force account. Agreed prices must be reached for any new or modified contract pay items related to the VECP before the VECP is approved.

The changes will be incorporated into the Contract by changes in quantities of unit bid items, new agreed unit price items, lump sum or any combination, as appropriate, under the Contract. Unless there is a differing site condition as described in subsection 103.02 of the Standard Specifications for Construction, the Contractor will not receive additional compensation for quantity overruns, design errors, supplemental surveys, geotechnical investigations, additional items or other increases in cost that were not foreseen in the accepted VECP, unless otherwise approved by the Engineer.

The work order and authorization will include the price for performing all affected items of work and the estimated net savings in the cost of performing the work directly attributable to the VECP. VECP payments only involve direct savings or costs. Indirect savings or costs (time, user delay, contract delay, etc) are not included in VECP payment calculations. The calculations of VECP payments are independent from the payments or penalties for contract time related issues. The Contractor will be paid 50 percent of this net savings based on as constructed or plan quantities whichever is in the best interests of the Department. The amount specified in the work order and authorization constitutes full compensation to the Contractor for the VECP and the performance of that work.

$$(\text{Cost of Deleted Work}) - (\text{Cost of Added Work}) = \text{Net Savings}$$

$$\text{Payment} = (\text{Net Savings})/2$$

Note: Approved VECP's will be paid using the pay item code "1200000", item description of "Value Engineering" and the pay unit is "Dollar" for the contract modification.

The Contractor's development costs for the proposed VECP, including all costs associated with design, are not reimbursable.

MICHIGAN  
DEPARTMENT OF TRANSPORTATION  
  
SPECIAL PROVISION  
FOR  
**SOURCE OF STEEL AND IRON (BUY AMERICA)**

CFS:JJG

1 of 3

APPR:RJC:DBP:01-08-13  
FHWA:APPR:01-08-13

**Delete subsection 105.10, on page 53 of the 2012 Standard Specifications for Construction, in its entirety and replace with the following:**

**105.10. Source of Steel and Iron.** Provide steel and iron materials and products for permanent incorporation into the work that were produced only in the United States per Title 23 of the Federal Code of Regulations (CFR) Section 635.410, Buy America Requirements.

All steel and iron products and manufacturing processes of the steel and iron material in a product, including but not limited to the following steps; smelting, melting, rolling, extruding, machining, bending, grinding, drilling, welding, galvanizing, and coating, must occur within the United States.

Examples of products that are subject to Buy America coverage include, but are not limited to, the following:

- A. Steel or iron products used in pavements, bridges, tunnels or other structures, which include, but are not limited to, the following: fabricated structural steel, reinforcing steel, piling, high strength bolts, anchor bolts, dowel bars, permanently incorporated sheet piling, bridge bearings, cable wire/strand, pre-stressing/post-tensioning wire, motor/machinery brakes and other equipment for moveable structures.
- B. Guardrail, guardrail posts, end sections, terminals, cable guardrail.
- C. Steel fencing material, fence posts.
- D. Steel or iron pipe, conduit, grates, manhole covers, risers.
- E. Mast arms, poles, standards, trusses, supporting structural members for signs, luminaires, or traffic control systems.
- F. Steel or iron components of precast concrete products, such as reinforcing steel, wire mesh and pre-stressing or post-tensioning strands or cables.

The miscellaneous steel or iron components, subcomponents and hardware necessary to encase, assemble and construct the above components (or manufactured products that are not predominantly (90 percent) steel or iron) are not subject to Buy America coverage. Examples include, but are not limited to, cabinets, covers, shelves, clamps, fittings, sleeves, washers, bolts, nuts, screws, tie wire, spacers, chairs, lifting hooks, faucets, door hinges, etc.

Provide step certification for all steel and iron related pay items, materials, products, and components as specified on the Department website. The Department will maintain a list of these pay items, materials, products, and/or components on the following website.

[http://www.michigan.gov/mdot/0,1607,7-151-9622\\_11044\\_11367---,00.html](http://www.michigan.gov/mdot/0,1607,7-151-9622_11044_11367---,00.html)

Step certification is defined as the certification by the respective manufacturer or fabricator for their specific process (step) that the product, material, or component was fabricated, manufactured, and/or processed in the United States. The step certification documentation for these pre-defined pay items, materials, products, and/or components is to be submitted to the Engineer in a package covering each step prior to delivery or concurrent with material delivery on-site. Approved certification is required prior to incorporation of the materials into the project.

Buy America certification documentation for products and materials designated as fully compliant with the Buy America requirements on the Qualified Products List (QPL), Approved Manufacturers, and Tested Stock Suppliers Lists will be maintained by the MDOT Construction Field Services (CFS) Division. Buy America certification for these fully compliant items does not need to be submitted by the Contractor, but a bill of lading, product label, or shipping record to document that the products are from the respective source is to be provided to the Engineer. Buy America certification documentation for items that are partially compliant will be required to be submitted prior to delivery or concurrent with material delivery and prior to incorporation, noting the value of foreign steel/iron. The use of the Department maintained Buy America lists and notations does not relieve the Contractor from responsibility of ensuring Buy America compliance. The Contractor is ultimately responsible for Buy America compliance.

The Buy America lists maintained by the Department are solely for the benefit of the Department and may not be relied upon by the Contractor. The Contractor is solely responsible for the Buy America requirements for steel and iron as set forth in the CFR.

The above requirements do not preclude a minimal use of foreign steel and iron, provided the total invoice cost of foreign material permanently incorporated into the project does not exceed 0.1 percent of the total contract amount or \$2,500 whichever is greater. The Department defines the total invoice cost as the total value of the foreign steel and iron materials delivered to the project. The Department defines the total contract amount to be the total of the contract unit prices for items of road work and bridge work, any adjustments as provided for in the contract, and any assessment of incentive, disincentive or liquidated damages as provided for in the contract.

MDOT/Consultant fabrication facility inspectors are not responsible for approving the incorporation of foreign steel/iron prior to fabrication. It is the responsibility of the fabricator to notify and coordinate with the Contractor for all potential inclusion of foreign steel/iron in fabricated products.

For each item subject to meeting Buy America requirements the following documentation must be provided by the Contractor to verify this value and placed in the project files to ensure that the threshold is not exceeded:

- Pay Item,
- Description of associated foreign steel/iron material, product, or component,
- Cost of associated foreign steel/iron material, product or component, and
- Cumulative list of all non-compliant Buy America items with the total dollar amount.

The minimal use of foreign steel/iron under the minimal usage amount will be approved by the Engineer. The use of foreign steel/iron under the minimal usage amount does not need to be approved by the FHWA. This amount is not considered a waiver to the Buy America requirements. The Contractor must ensure that the minimal usage amount is not exceeded.

MICHIGAN  
DEPARTMENT OF TRANSPORTATION

SPECIAL PROVISION  
FOR  
**NATIONAL POLLUTANT DISCHARGE ELIMINATION SYSTEM INSPECTION AND  
RESPONSE**

CFS:DMG

1 of 1

APPR:TWK:HZ:07-02-14

FHWA:APPR:07-09-14

**a. Description.** There is the potential for disturbance of land totaling five acres or greater during construction of this project. Therefore, 1994 PA 451, Part 31 (Water Resources Protection) and Part 21 (Wastewater Discharge Permit Rules/National Pollutant Discharge Elimination System [NPDES]), apply to this project. The Department has filed a Notice of Coverage with the MDEQ. The MDEQ will return an authorization number to the Department.

The Engineer, in accordance with the NPDES regulations, will assign a Certified Storm Water Operator (SWO) to make project-wide reviews for NPDES compliance. Reviews will be made on projects with earth disturbances one acre or greater once every 7 days, and within 24 hours after every precipitation event that results in runoff from the site and ensure the completion of any needed corrective actions. A log of the inspections and corrective actions will be maintained on file for review and will be retained for a period of 3 years from the date of the inspection or corrective action.

The SWO will document the inspections and corrective actions onto the NPDES and Soil Erosion and Sedimentation Control Inspection Report (MDOT Form 1126). Deficiencies will be brought to the attention of the Contractor and this notice must include a deadline for completing the corrective actions.

The Contractor has a period of 5 calendar days in which to complete, or have completed, all corrective actions except those of an emergency nature required as a result of the NPDES inspection as indicated on Form 1126. Corrective actions of an emergency nature will be as determined by the Engineer and include sedimentation that occurs in streams, drainage structures, or watercourses, or erosion that affects the support of the roadbed or the safety of the public. Emergency corrective actions will be noted as such on Form 1126 and must be completed in an acceptable manner by the Contractor within 24 hours after notification.

MICHIGAN  
DEPARTMENT OF TRANSPORTATION

SPECIAL PROVISION  
FOR  
**CONSTRUCTION STAGING AREAS**

DES:LFS

1 of 1

C&T:APPR:JJG:KAS:10-06-11  
FHWA:APPR:10-11-11

**Add the following subsection to section 107, on page 70 of the 2012 Standard Specifications for Construction:**

**107.22 Construction Staging Areas.** The contractor must not use any public recreation area as a staging area, marshalling yard, storage facility, or for any other construction support unless it is defined in the contract.

Public recreation areas include: parks, trails, game areas, wildlife and waterfowl refuges, playgrounds, golf courses, athletic fields or similar areas which are publically owned by public school districts, local, state, or federal governments.

Any agreements negotiated between the Contractor and the owner of the public recreation area, before or after the award of the contract will not be considered valid by the Department.

If the Engineer determines the Contractor is in non-compliance with this subsection, penalties up to and including termination of the contract, in accordance with subsection 108.12, may be enacted as well as the immediate restoration of the public recreation area at the Contractor's cost.

MICHIGAN  
DEPARTMENT OF TRANSPORTATION

SPECIAL PROVISION  
FOR  
**E-VERIFY**

CSD:JDM

1 of 1

APPR:JJG:JC:10-24-12  
FHWA:APPR:10-25-12

**a. Description.** E-Verify is an Internet-based system that allows an employer, using information reported on an employee's Form I-9, Employment Eligibility Verification, to determine the eligibility of that employee to work in the United States. There is no charge to employers to use E-Verify. The E-Verify system is operated by the Department of Homeland Security (DHS) in partnership with the Social Security Administration. E-Verify is available in Spanish.

The State of Michigan is requiring all Contractors, and Subcontractors, to verify that new employees are legally present and authorized to work in the United States, using the E-Verify System.

Information on registration for and use of the E-Verify program can be obtained via the Internet at the DHS Web site: <http://www.dhs.gov/E-Verify>.

It is the responsibility of the Contractor to include this specification in all tiers of subcontracts.

Verification of the Contractors' use of E-verify will be a part of the random review of subcontract information performed by Contract Services Division.

The required use of the E-Verify system will not be paid for separately as part of the contract but is considered included in the costs for other pay items in the contract.

MICHIGAN  
DEPARTMENT OF TRANSPORTATION

SPECIAL PROVISION  
FOR  
**LABOR COMPLIANCE**

CFS:AS

1 of 2

APPR:JJG:RJC:07-01-14  
FHWA:APPR:07-09-14

**a. Description.** This special provision details the requirements for labor compliance. Ensure all levels of contracting (prime, sub, sub-sub, etc.) comply with all labor compliance requirements in this contract as well as with the current MDOT procedure for prevailing wage oversight. All contractors must insert this special provision in each subcontract and further require its inclusion in all lower tier subcontracts. The Contractor must advise all subcontractors of the requirement to pay the prevailing wage rates prior to commencement of work and that all employees must cooperate during wage rate interviews. The Contractor is responsible for all subcontractors and lower tier subcontractor labor compliance. Ensure labor compliance posters and the project specific prevailing wage rates are posted on the construction site, in a conspicuous place, prior to the commencement of work. Resolve all labor compliance issues within 60 days of receiving the Department's first documented notice. The 60 day requirement may be extended based on documented mutual agreement between the Department and the Contractor. A violation of state and/or federal prevailing wage rates or laws may result in the debarment of a Contractor from being awarded a contract or subcontract for a period of up to 8 years. Other actions, including but not limited to the reconciliation of records and restitution for employees, included in state and federal laws, may be required of the Contractor or subcontractor.

1. Record Keeping. Maintain payrolls and basic records relating thereto (i.e. W2, canceled checks, bank statements, payroll software etc.) by all levels of contractors during the course of work and preserved for a period of 3 years thereafter for all employees working on the site of work as outlined in 29 Code of Federal Regulations part 5.5 (29 CFR 5.5). Make these records available for inspection, copying, or transcription by the Department or its representative.

2. Certified Payroll Submittal Requirements. Subcontractors (all tiers) must submit their certified payrolls to the prime Contractor. The submitted payrolls must set out accurately and completely all of the information required on MDOT Form CP-347, Certified Payroll. The required weekly payroll information may be submitted on any contractor generated form, but must contain all information required on Form CP-347. Review all lower tier subcontractor certified payrolls prior to submission to the Engineer. The review must ensure the certified payroll complies with the submittal requirements as set forth in the current MDOT procedure for prevailing wage oversight. Complete Form 1955, Contractor's Certified Payroll Report, and submit to the Engineer along with the certified payrolls on a weekly basis. Forms 1955 and CP-347 are available on the MDOT forms webpage.

A. Federal Prevailing Wage Projects. The Davis-Bacon Related Acts apply to all contractors, and subcontractors (all tiers) performing work on federally funded or assisted construction contracts in excess of \$2,000. All contractors and subcontractors are required to comply with 29 Code of Federal Regulations Parts 1, 3, and 5.



B. State Prevailing Wage Projects. 1965 PA 166 applies to all contractors, and subcontractors (all tiers) performing work on contracts which are sponsored or financed in whole by the State of Michigan. On contracts involving two or more job numbers where the type of funding is mixed, and where one source of funding is federal, the Department inserts only the wage rates issued by the U.S. Department of Labor in the proposal and the federal requirements apply.

3. Short Duration Projects. The following modifications apply to the prevailing wage oversight procedure if the project is less than 75 calendar days in duration.

A. Submittal Requirements. The first certified payroll is to be received by the Engineer within 2 weeks from the end of the work week in which the work is started by the Contractor and/or subcontractors. The 2 week period is to allow for the processing and review of the certified payrolls by the Contractor. The first pay estimate can be made prior to the submission of the first certified payroll. The 2 week grace period allows the first estimate to be paid assuming the Contractor and subcontractor submit certified payrolls in a timely manner. Ensure subsequent certified payroll submissions are made weekly. Payroll submissions failing to meet the above requirements will be considered delinquent.

B. Contractor Notices. When certified payrolls are determined to be deficient or delinquent as defined in the current MDOT procedures for prevailing wage oversight the Engineer is to provide the prime Contractor with documented notice.

All labor compliance issues are to be resolved within 30 days after receiving the Department's first documented notice. The notification timeframe will be modified from 30 calendar days per notification to 15 calendar days per notification for short duration projects.

**b. Materials.** None specified.

**c. Construction.** None specified.

**d. Measurement and Payment.** Payment for compliance with this special provision will not be made separately. Payment will be considered as part of all other contract pay items.

MICHIGAN  
DEPARTMENT OF TRANSPORTATION  
  
SPECIAL PROVISION  
FOR  
**ON-THE-JOB TRAINING PROGRAM**

OBD:TDB

1 of 1

C&T:APPR:DBP:GCT:04-21-11  
FHWA:APPR:06-01-11

**a. Description.** The On-The-Job Training (OJT) program is the MDOT's program to meet the requirements of the Federal-Aid Highway Act of 1970 and 23 CFR (Code of Federal Regulations) Part 230, Subpart A. The objective is to develop skill improvement programs to provide opportunities for unskilled workers, particularly minorities, women, and disadvantaged persons, to acquire training in the skilled construction trades.

**b. Trainee Assignment.** MDOT's Office of Business Development will allocate training assignments to prequalified Contractors based on the past contract volume of federal-aid work performed with MDOT. MDOT will notify each Contractor who has met the volume of work threshold at the beginning of each calendar year and advise them of the number of trainees they are expected to support.

**c. Program Requirements.** Contractors found to have reached the level(s), as identified in the MDOT OJT program document, are required to fulfill all of the requirements of the OJT program at no additional cost to the Department.

The Contractors are required to pay the trainees in accordance with the following schedule:

- 60 percent of the appropriate minimum journeyman's rate specified in the contract for the first half of the training period
- 75 percent for the third quarter of the training period
- 90 percent for the last quarter of the training period
- Full fringe benefits will be paid during the entire training period

The OJT program document is available through the MDOT's On-the-Job Training Program website at [www.michigan.gov/mdot/0,1607,7-151-9625-214452--,00.html](http://www.michigan.gov/mdot/0,1607,7-151-9625-214452--,00.html).

Contractors should notify the Engineer at the preconstruction meeting if they intend to utilize trainees on the project.

**d. Non-Compliance.** Failure to comply with the OJT program provisions or complete a training assignment may result in the Contractor being found in non-compliance. Failure to resolve the non-compliance may be used as a basis for modifying the prequalification ratings of the Contractor. Any action to modify the Contractor's prequalification ratings will be taken in accordance with the duly promulgated prequalification rules.

MICHIGAN  
DEPARTMENT OF TRANSPORTATION

SPECIAL PROVISION  
FOR  
**PROMPT PAYMENT**

CFS:JJG

1 of 4

APPR:JDM:DBP:07-29-13  
FHWA:APPR:08-06-13

**Add the following subsection to section 109, on page 106, of the Standard Specifications for Construction:**

**109.08 Prompt Payment.**

**A. Definitions.**

**Lower-tier subcontract.** An agreement between a subcontractor of any tier and any individual or legal entity to perform a part of the subcontract work.

**Lower-tier subcontractor.** The individual or legal entity that performs part of the subcontract work through a lower-tier subcontract with a subcontractor.

**Supplier.** The individual or legal entity that agrees to provide materials or services to the prime Contractor, a subcontractor, or a lower-tier subcontractor for the performance of their contract work.

**Sworn Statement.** A written verification under oath reflecting all persons or entities, which have furnished labor, equipment, services or materials to a subcontractor or lower-tier subcontractor for performance of work on the project. The written verification includes union fringe benefit funds, original contract amount, current amount due, amounts paid to date and balance to finish the work for each person or entity.

**Waiver of Lien.** A written release and waiver of any claim or right to payment for payments actually received for labor, equipment, services or materials furnished for performance of work on the project.

The sworn statement and waiver of lien documents are used by the prime Contractor and its subcontractors for verifying payments made to lower-tier subcontractors/suppliers and are not to be submitted to the Engineer unless requested as an aid in determining an alleged prompt payment violation. These documents can be found at the following website under the Construction Field Services heading:

[http://www.michigan.gov/mdot/0,1607,7-151-9622\\_11044\\_11367---,00.html](http://www.michigan.gov/mdot/0,1607,7-151-9622_11044_11367---,00.html)

**B. Progress Payments.** For the first payment, or for a one time payment, the prime Contractor agrees to pay each subcontractor for the work associated with their subcontract no later than 10 calendar days from the date the prime Contractor receives payment from the Department.

For the second and subsequent payments, the prime Contractor agrees to pay each

subcontractor for the work associated with their subcontract no later than 10 calendar days from the date the prime Contractor receives payment from the Department.

The Contractor is required to provide payment information for previous payments made to subcontractors and suppliers before the Engineer will release the third and subsequent estimates. The payment information is provided through submittal of the information via the 2124A reporting system (MERS). System information can be found at the following web link.

[http://www.michigan.gov/documents/mdot/Prompt\\_Payment\\_2124A\\_Instructions\\_MERS\\_366314\\_7.pdf](http://www.michigan.gov/documents/mdot/Prompt_Payment_2124A_Instructions_MERS_366314_7.pdf)

The prime Contractor must bring any concerns about the satisfactory completion of subcontractor or lower-tier subcontractor work items, to the Engineer's attention as soon as the concern is discovered. If the work meets the requirements of satisfactory completion and the prime Contractor has been paid for that work, the Engineer must determine whether:

1. The prime Contractor has demonstrated a valid reason for withholding payment from the subcontractor or supplier, or
2. The subcontractor has demonstrated a valid reason for withholding payment from the lower-tier subcontractor or supplier.

If the Engineer determines the reason for withholding payment is valid, the Engineer will process a negative estimate to withdraw the amount involved in the complaint. If payment has not been made for the work related to the complaint, the Engineer will not include those items of work on an estimate until the issue has been resolved.

The prime Contractor remains responsible to make prompt payments on this project to their subcontractors and suppliers except as noted in subsection 109.08.D of this special provision, even if the prime Contractor is in violation of other contractual obligations and the Department is withholding payment from the prime Contractor for those violations.

The prime Contractor must include language in all subcontracts that the Department prohibits prime Contractors from holding retainage from subcontractors. All provisions of this prompt payment subsection apply to all subcontracts, lower-tier subcontracts, and supplier agreements and must be included in each subcontract for the contract, including all lower-tier subcontracts and agreements.

This prompt payment provision is a requirement of 49 CFR 26.29 and does not confer third-party beneficiary rights or other direct rights to a subcontractor against the Department. This provision applies to both DBE and non-DBE subcontractors/suppliers at all tiers.

**C. Satisfactory Completion.** Progress and partial payments for contract work are issued based on the satisfactory completion of work. Satisfactory completion, for purposes of this prompt payment provision, is defined as:

1. Upon preliminary review, the Engineer finds the work completed in accordance with the contract, plans, and specifications; and,
2. Required documentation, including material certifications, payrolls, submission of 2124A, etc., has been received and reviewed and found to be acceptable by the Engineer; and,

3. Required subcontractor sworn statements and waivers of lien have been provided to the prime Contractor. The prime Contractor must provide notice to the Engineer if sworn statements and waivers of lien have not been received for completed work.

The Engineer will determine if the work meets the standards of satisfactory completion.

D. **Less than full payment release.** The Engineer may give written approval to:

1. Delay or postpone payment from the time frames specified herein,
2. Process partial payment from the prime Contractor to a subcontractor or supplier,
3. Process partial payment from a subcontractor to a lower-tier subcontractor or supplier.

The unpaid portion will be held by the Department.

The parties may initiate whatever dispute resolution procedure is specified in their agreement or is available under Michigan law. If dispute resolution or litigation is selected, the actions by both parties must proceed in a timely manner. The result of the dispute resolution proceeding or litigation must be provided to the Engineer promptly upon the conclusion of the proceeding. The Engineer will release the disputed payment being held by the Department in accordance with the outcome of the proceedings.

E. **Non-Payment Claims.** The prime Contractor, subcontractor, lower-tier subcontractor or supplier must notify the alleged offending party in writing of any prompt payment violations within 30 calendar days of the date the payment was to be received. Copies of the notifications must be provided to the Engineer and the prime Contractor (only if the prime Contractor is not the offending party).

The alleged offending party must respond in writing to the claimant within 10 calendar days of receipt of the notification of failure to meet prompt payment provisions. Copies of the response must be provided to the Engineer, the prime Contractor (only if the prime Contractor is not the offending party), and the Engineer of Construction Field Services. The prime Contractor, subcontractor, or supplier must also provide the required sworn statements and waivers of lien from the affected subcontractor or supplier to the Engineer within 10 days of receipt of the notification. The Department will consider the failure of the alleged offending party to respond to the notification from the claimant as an admission of the prompt pay violation which may result in sanctions.

The Engineer will review the written notice and response and will verify in writing if there is a valid prompt pay violation.

Independent of all procedures and requirements in this special provision the non-payment claimant has the additional option of submitting a lien claim to the MDOT Contract Services Division. MDOT will notify the project surety of the non-payment issue. It is the responsibility of the surety to ensure that all legitimately due payments are made. The submission of a lien claim will not nullify or affect any other requirements, obligations or procedures in this special provision.

F. **Remedies.** When the Engineer verifies a prompt payment violation, the prime Contractor within 5 days must propose one or a combination of any of the following actions items for review

and approval by the Engineer:

1. Issue payment to the subcontractor.
2. Issue payments to a subcontractor in the form of joint checks to the subcontractor and the subcontractor's lower-tier subcontractors and/or suppliers.
3. Issue payment directly to the subcontractor's lower-tier subcontractors or suppliers.
4. Request a negative estimate to withdraw the amount confirmed in the prompt payment violation.

If the prime Contractor fails to submit a timely remedy request or obtain an approved course of action within the 5 day time period, the Engineer will direct a course of action or issue a negative estimate to withdraw the amount confirmed in the prompt payment violation.

If the prime Contractor fails to fulfill the approved or directed course of action the Engineer will impose sanctions until such time as the approved or directed course of action is completed.

Any payments to a subcontractor's lower-tier subcontractor or supplier will be issued in the amounts reflected upon the subcontractor's sworn statements or in amounts independently verified by the Engineer as being due the subcontractor's lower-tier subcontractors and suppliers for work completed. Payments to a lower-tier subcontractor or supplier will be considered payment to the subcontractor directly so that payment for the same work cannot be claimed.

Any other use of joint checks must follow current Department procedures.

**G. Sanctions.** Failure to comply with any of the prompt payment requirements by the prime Contractor, subcontractor, lower-tier subcontractor, or supplier may result in sanctions against the offending party. These sanctions may include, but are not limited to: withholding of estimates on projects where prompt payment violations are confirmed; reduction or removal of prequalification; and/or suspension of bidding privileges.

MICHIGAN  
DEPARTMENT OF TRANSPORTATION

SPECIAL PROVISION  
FOR  
**NON-COMPLIANCE WITH SOIL EROSION AND SEDIMENTATION CONTROL  
REQUIREMENTS**

CFS:DMG

1 of 2

APPR:TWK:HZ:07-02-14  
FHWA:APPR:07-09-14

**a. Description.** This special provision establishes negative adjustments related to the failure to properly install and maintain soil erosion and sedimentation control (SESC) measures and the conditions under which these adjustments will be determined and applied. Nothing in this special provision modifies section 107 of the Standard Specifications for Construction.

Delays to the project as a result of the Contractor conducting corrective actions for SESC measures do not constitute a valid reason for an extension of time.

Ensure deficiencies with SESC measures are corrected in the time frame stated herein. For those deficiencies not corrected within the stated time frame, the Engineer will make a negative adjustment to the contract as stated herein.

**b. Materials.** None specified.

**c. Construction.** Install all temporary erosion control measures identified on the plans and as directed by the Engineer for an impacted area of the project prior to the start of any earth disturbance including, but not limited to, clearing, grading and excavation in that area. The Engineer will inspect these measures every 7 days and within 24 hours of precipitation events which result in off-site runoff. Deficiencies will be documented on the National Pollutant Discharge Elimination System and SESC Inspection Report (MDOT Form 1126).

If at any time during the project, including the time during the seasonal suspension, the Engineer documents deficient SESC measures, the Engineer will provide written notification with instructions for corrective action to the Contractor. The time frame for completion of these corrective actions will be specified in the notification and will be discussed with the Contractor as necessary.

Deficiencies are defined as one or more of the following:

1. Failure to install or construct SESC measures shown on the plans or as directed by the Engineer;
2. Failure to maintain the measures;
3. Failure to conduct earth change activities in a manner consistent with all applicable environmental permit requirements;
4. Failure to comply with the area limitations or the time limitations stated in subsections 208.03.A and 208.03.B, respectively, of the Standard Specifications for

Construction.

SESC deficiencies are either emergency or non-emergency and the time frame for corrective action is determined accordingly. Sedimentation of a drainage structure or waters of the state or loss of support of the roadbed impacting public safety constitutes an emergency and corrective actions must be completed within 24 hours of notification. Non-emergency deficiencies must be corrected within 5 calendar days of notification.

For those emergency corrective actions not completed within 24 hours of notification, the Contractor will be assessed \$100.00 per hour for every hour the deficiency remains uncorrected after the initial 24 hours of notification. For those non-emergency corrective actions not completed within 5 calendar days, the Contractor will be assessed \$500.00 per day for every day, or part thereof, the deficiency remains uncorrected after the initial 5 days of notification.

If it is not practicable to complete the non-emergency corrective actions within 5 calendar days, the Contractor must document the reasons and propose a corrective action plan to the Engineer within 5 days of notification. The corrective action plan must contain the Contractor's course of action and a time frame for completion. If the reasons and the corrective action plan are acceptable to the Engineer, the Contractor will be allowed to proceed with the plan as proposed without incurring a negative adjustment. If the approved corrective action plan is not completed as proposed, the Contractor will be assessed \$1000.00 per calendar day for every day, or part thereof, the deficiency remains uncorrected after the time frame is exceeded in the approved corrective action plan.

Correct, in the timeframe stated herein, all other emergency or non-emergency SESC deficiencies documented anywhere else on the project during completion of the approved corrective action plan.

**d. Measurement and Payment.** The Engineer will make the necessary monetary adjustment to the contract amount based on the length of time the Contractor allows the deficiencies to remain uncorrected after the time allowance stated herein and as described to cover any costs incurred by the Department as a result of SESC violations.

All costs associated with corrective actions required due to the Contractor's failure to properly install or maintain SESC measures on this project will be borne by the Contractor.



MICHIGAN  
DEPARTMENT OF TRANSPORTATION

SPECIAL PROVISION  
FOR  
**SEDIMENT FILTER FENCE**

CFS:DMG

1 of 1

APPR:TWK:HZ:03-11-14  
APPR:FHWA:04-25-14

**a. Description.** This work consists of the installation of sediment filter fence (fence) as an acceptable alternative to geotextile silt fence for soil erosion and sedimentation control.

The use of the fence is restricted for those applications with a maximum gradient of 1 on 10 (10 percent) or flatter.

**b. Materials.** The fence must be manufactured with a polypropylene filter fabric fabricated between two layers of extruded polypropylene impermeable barrier. The fence must be a nominal 20 inches in height and have drainage holes through the extruded polypropylene barrier. The holes must be a nominal 5/8 inch in diameter and have random spacing at approximately 20 holes per lineal foot of fence.

The polypropylene fabric must meet the physical requirements for Apparent Opening Size (*ASTM D 4751*) and Permittivity (*ASTM D 4491*) listed for Silt Fence in Table 910-1 of the Standard Specifications for Construction. Provide Test Data Certification as described in the *Materials Quality Assurance Procedures Manual* for the polypropylene fabric for acceptance.

Support stakes for the fence must be manufactured from fiberglass and be a nominal 30 inches in length and 1/2 inch in diameter.

**c. Construction.** Install the fence at the locations shown on the plans where geotextile silt fence would be required or as directed by the Engineer. The work must be conducted in accordance with section 208 of the Standard Specifications for Construction and the manufacturer's published installation instructions. The fence must be trenched in a minimum of 6 inches and support stakes installed as needed or as directed by the Engineer.

Maintain the fence as necessary and remove and dispose of in accordance with the standard specifications when no longer needed or as directed by the Engineer.

**d. Measurement and Payment.** The completed work, as described, will be measured and paid for at the contract unit price using the following pay item:

<b>Pay Item</b>	<b>Pay Unit</b>
Erosion Control, Sediment Filter Fence .....	Foot

MICHIGAN  
DEPARTMENT OF TRANSPORTATION

SPECIAL PROVISION  
FOR  
**SAMPLING ASPHALT BINDER ON LOCAL AGENCY PROJECTS**

C&amp;T:MF

1 of 1

C&T:APPR:JAR:JTL:12-19-01  
FHWA:CON. APPR:06-06-11

For informational purposes, original samples of asphalt binder will be taken by the Contractor and delivered to the Engineer prior to incorporation into the mixture. The frequency of sampling shall be determined by the Engineer. The cost of obtaining and delivering the samples to the Engineer will be included in the hot mix asphalt (HMA) pay items.

The Contractor must certify in writing that the materials used in the HMA mixture are from the same source as the materials used in developing the HMA mixture design and the bond coat is from an approved supplier as stated in MDOT's Material Quality Assurance Procedures Manual.

MICHIGAN  
DEPARTMENT OF TRANSPORTATION

SPECIAL PROVISION  
FOR  
**RECYCLED HOT MIX ASPHALT MIXTURE ON LOCAL AGENCY PROJECTS**

CFS:KPK

1 of 2

APPR:JWB:CJB:03-13-14

FHWA:APPR:03-13-14

**Add the following subsection to subsection 501.02.A.2, on page 234 of the Standard Specifications for Construction.**

- c. **Reclaimed Asphalt Pavement (RAP) and Binder Grade Selection.** The method for determining the binder grade in HMA mixtures incorporating RAP is divided into three categories designated Tier 1, Tier 2 and Tier 3. Each tier has a range of percentages that represent the contribution of the RAP binder toward the total binder, by weight. The tiers identified below apply to HMA mixtures with the following exception: Superpave mixture types E3, E3 High Stress, E10, E10 High Stress, E30, E30 High Stress, E50, and E50 High Stress used as leveling or top course must be limited to a maximum of 27 percent RAP binder by weight of the total binder in the mixture.

Recycled materials may be used as a substitute for a portion of the new materials required to produce HMA mixtures in accordance with contract.

- **Tier 1 (0% to 17% RAP binder by weight of the total binder in the mixture).** No binder grade adjustment is made to compensate for the stiffness of the asphalt binder in RAP.
- **Tier 2 (18% to 27% RAP binder by weight of the total binder in the mixture).** For all mixtures no binder grade change will occur in Tier 2 for all shoulder and temporary road mixtures.

The required asphalt binder grade must be at least one grade lower for the low temperature than the design binder grade required for the specified project mixture type. Lowering the high temperature of the binder one grade is optional. For example, if the design binder grade for the mixture type is PG 58-22, the required grade for the binder in the HMA mixture containing RAP would be a PG 52-28 or a PG 58-28.

For Marshall Mixes, no binder grade change will be required when Average Daily Traffic (ADT) is above 7000 or Commercial Average Daily Traffic (CADT) is above 700. No binder grade change will occur for LVSP, E03 and E1 mixtures used as leveling or top course.

The asphalt binder grade can also be selected using a blending chart for high and low temperatures. Supply the blending chart and the RAP test data used in determining the binder selection according to *AASHTO M 323*.

- **Tier 3 ( $\geq$  28% RAP binder by weight of the total binder in the mixture).** The

binder grade for the asphalt binder is selected using a blending chart for high and low temperatures per *AASHTO M 323*. Supply the blending chart and the RAP test data used in determining the binder selection.

MICHIGAN  
DEPARTMENT OF TRANSPORTATION

SPECIAL PROVISION  
FOR  
**MARSHALL HOT MIX ASPHALT MIXTURE**

C&T:JWB

1 of 2

C&T:APPR:EHR:CJB:09-25-06  
FHWA:APPR:06-06-11

**a. Description.** Furnish hot mix asphalt (HMA) mixture, designed using Marshall Mixture Design Methods, in accordance with the standard specifications except as modified by this special provision.

**b. Mix Design.** Submit the mix design for evaluation in accordance with the Department's HMA Production Manual. Use a 50 blow Marshall hammer when compacting mixtures for developing Marshall mix designs.

**c. Recycled Mixtures.** Substituting reclaimed asphalt pavement (RAP) for a portion of the new material required to produce HMA mixture is allowed provided that the mixture is designed and produced to meet all criteria specified herein, unless otherwise prohibited. RAP materials must be in accordance with the standard specifications.

**d. Materials.** Table 1 provides the mix design criteria and volumetric properties. Table 2 provides the required aggregate properties. Use aggregates of the highest quality available to meet the minimum specifications. Use the mixture designation number shown in the contract item name when determining mix design properties from Tables 1 and 2.

**e. Measurement and Payment.** The completed work, as described, will be measured and paid for at the contract unit price using the following pay item:

Pay Item	Pay Unit
HMA, (type) .....	Ton

**Table 1: Mix Design Criteria and Volumetric Properties**

	Mixture No.				
	2C	3C	4C	13A	36A
Target Air Void, % (a)	3.00	4.00	4.00	4.00	4.00
VMA (min) (b)	11.00	13.00	14.00	14.00	15.00
VFA	65-78	65-78	65-78	65-78	65-78
Fines to Binder Ratio (max) (c)	1.2	1.2	1.2	1.2	1.2
Flow (0.01 inch)	8 -16	8 -16	8 -16	8 -16	8 -16
Stability (min), lbs	1200	1200	1200	900	900

- a. Lower target air voids by 1.00% if used in a separate shoulder paving operation. Consider reducing air void targets to 3.00% for lower traffic volume roadways when designing 13A and 36A mixtures for local agency use.
- b. VMA calculated using Gsb of the combined aggregates.
- c. Ratio of the weight of aggregate passing the No. 200 sieve to total asphalt binder content by weight; including fines and binder contributed by RAP.

**Table 2: Aggregate Properties**

	Mixture No.				
	2C	3C	4C	13A	36A
	Percent Passing Indicated Sieve or Property Limit				
1 1/2 inch	100				
1 inch	91-100	100			
3/4 inch	90 max.	91-100	100	100	
1/2 inch	78 max.	90 max.	91-100	75-95	100
3/8 inch	70 max.	77 max.	90 max.	60-90	92-100
No. 4	52 max.	57 max.	67 max.	45-80	65-90
No. 8	15-40	15-45	15-52	30-65	55-75
No. 16	30 max.	33 max.	37 max.	20-50	
No. 30	22 max.	25 max.	27 max.	15-40	25-45
No. 50	17 max.	19 max.	20 max.	10-25	
No. 100	15 max.	15 max.	15 max.	5-15	
No. 200	3-6	3-6	3-6	3-6	3-10
Crushed (min), % (MTM 117)	90	90	90	25	60
Soft Particle (max), % (a)	12.0	12.0	8.0	8.0	8.0
Angularity Index (min) (b)	4.0	4.0	4.0	2.5	3.0
L.A. Abrasion (max), % loss (c)	40	40	40	40	40
Sand Ratio (max) (d)	-	-	-	50	50
<p>a. The sum of the shale, siltstone, structurally weak, and clay-ironstone particles must not exceed 8.0 percent for aggregates used in top course. The sum of the shale, siltstone, structurally weak, and clay-ironstone particles must not exceed 12.0 percent for aggregates used in base and leveling courses.</p> <p>b. The fine aggregate angularity of blended aggregates, determined by MTM 118, must meet the minimum requirement. In mixtures containing RAP, the required minimum fine aggregate angularity must be met by the virgin material. NAA fine aggregate angularity must be reported for information only and must include the fine material contributed by RAP if present in the mixture.</p> <p>c. Los Angeles abrasion maximum loss must be met for the composite mixture, however, each individual aggregate must be less than 50</p> <p>d. Sand ratio for 13A and 36A no more than 50% of the material passing the No. 4 sieve is allowed to pass the No. 30 Sieve.</p>					

MICHIGAN  
DEPARTMENT OF TRANSPORTATION  
  
SPECIAL PROVISION  
FOR  
**ACCEPTANCE OF HMA MIXTURE ON LOCAL AGENCY PROJECTS**

C&amp;T:JWB

1 of 2

C&T:APPR:JWB:JAR:07-27-04  
FHWA:CON. APPR:06-06-11

**a. Description.** This special provision provides acceptance testing requirements for use on local agency projects that do not include the quality control/quality assurance special provision. The HMA mixture provided must meet the requirements of the standard specifications, except where modified herein.

**b. Materials.** Provide a mixture of aggregates, mineral filler (if required), and asphalt binder proportioned to be within the master gradation limits shown in the project documents, and meeting the uniformity tolerances listed in Table 1. The master gradation range is to be used for establishing mix design only. Topsoil, clay, or loam can not be added to aggregates which are to be used in plant mixed HMA mixtures.

**c. Construction.** After the job-mix-formula (JMF) is established, the aggregate gradation and the binder content of the HMA mixture furnished for the work must be maintained within the Range 1 uniformity tolerance limits permitted for the JMF specified in Table 1. However, if deviations are predominantly either below or above the JMF, the Engineer may order alterations in the plant to bring the mixture to the JMF. If two consecutive aggregate gradations on one sieve, or binder contents as determined by the field tests, are outside Range1 but within Range 2 tolerance limits, the Contractor must suspend all operations. Contract time will continue during these times when the plant is down. Before resuming any production, the Contractor must propose, for the Engineer's approval, all necessary alterations to the materials or plant so that the JMF can be maintained. The Engineer will evaluate the alterations for there effects on AWI and mix design properties and will approve or disapprove the alterations.

The Engineer will perform acceptance sampling and testing. Each day of production, a minimum of two samples will be obtained for each mix type. Acceptance testing will be performed at the frequency specified by the Engineer. No less than three samples will be obtained for each mix type. Quality control measures to insure job control are the responsibility of the Contractor.

The crushed particle content of the aggregate used in the HMA mixture must not be more than 10 percentage points above or below the crushed particle content used in the JMF nor less than the minimum specified for the aggregate in the contract.

Establish a rolling pattern that will achieve the required in place density. The Engineer will measure pavement density with a Nuclear Density Gauge using the Gmm from the JMF for the density control target. The required in place density of the HMA mixture must be 92.0 to 96.0 percent of the density control target.

**Table 1: Uniformity Tolerance Limits for HMA Mixtures**

PARAMETER	TOP & LEVELING COURSE		BASE COURSE	
	Range 1(a)	Range 2	Range 1(a)	Range 2
Binder Content	± 0.40	± 0.50	± 0.40	± 0.50
% Passing # 8 and Larger Sieves	± 5.0	± 8.0	± 7.0	± 9.0
% Passing # 30 Sieve	± 4.0	± 6.0	± 6.0	± 9.0
% Passing # 200 Sieve	± 1.0	± 2.0	± 2.0	± 3.0
a. This range allows for normal mixture and testing variations. The mixture must be proportioned to test as closely as possible to the Job-Mix-Formula.				

**d. Rejected Mixtures.** If for any one mixture, two consecutive aggregate gradations on one sieve or binder contents as determined by field tests exceed the uniformity tolerance of Range 2 under Table 1, or do not meet the minimum requirements for crushed particle content specified in the project documents, the mixture will be rejected. If such mixtures are placed in a pavement, the remaining portions of the failing field samples (split sample) will be sent to the MDOT Central Laboratory to confirm the field test results. If the Laboratory's results do not confirm the field test results and there are no price adjustments required due to test failures on the asphalt binder, then no price adjustments will be made for the mixture involved. If the Laboratory's results confirm the field test results and if, in the Engineer's judgment, the defective mixture can remain in place and there are no price adjustments required due to test failures on the asphalt binder, the contract unit price for the defective mixture involved, as determined from field tests, will be decreased on the following basis:

The contract unit price for material outside of Range 2 or with a crushed particle content below that specified in the project documents will be decreased 25 percent.

If three consecutive aggregate gradations on one sieve, or bitumen contents as determined by field tests are outside Range 1 but within Range 2 tolerance limits, the mixture produced from the time the third sample was taken until the gradation, or bitumen content is corrected back into Range 1 will be decreased in contract unit price by 10 percent. Field tests indicating that mixtures are subject to the 10 percent penalty will be confirmed in the same manner as mixtures subject to the 25 percent penalty as described herein.



MICHIGAN  
DEPARTMENT OF TRANSPORTATION

SPECIAL PROVISION  
FOR  
TRAFFIC CONTROL QUALITY AND COMPLIANCE

OPR:JJG

1 of 2

C&T:APPR:CER:DBP:01-20-11  
FHWA:APPR:06-20-11

Delete the subsection 812.03.C, Deficient Traffic Control Operations on page 601 of the Standard Specifications for Construction in its entirety, and replace with the following.

**C. Deficient Traffic Control Operations.**

1. **Traffic Control Quality and Compliance.** The following applies to all aspects of the traffic control plan and traffic control devices except the Type D lights on plastic drums which are covered elsewhere in the contract.

a. **Traffic Control not Anticipated in Design.** If at any time during the project, including the time during the seasonal suspension, the Engineer documents that the traffic control requires improvements beyond the scope of the Traffic Control Plan, the Engineer will provide written instructions to the Contractor and traffic control supplier what improvements are required. The Contractor must develop and submit to the Engineer for approval, a written implementation schedule for improvements. If the schedule is not approved, or if the schedule is approved but is not followed, the Department will adjust the contract according to subsection 812.03.C.1.c.iii. If the implementation schedule is not followed, the Engineer will notify the Contractor and traffic control supplier in writing that they are in violation of this subsection. The work of making traffic control improvements directed by the Engineer that are beyond the scope of the Traffic Control Plan will be paid for as extra work.

b. **As Designed Traffic Control.** If at any time during the project, including the time during the seasonal suspension, the Engineer documents that the traffic control is deficient, inadequate or improperly placed, the Engineer will provide written notification with instructions for corrective action to the Contractor and traffic control supplier. Upon receipt of the notification of corrective action, the Contractor has 4 hours to correct the traffic control. If the traffic control cannot be corrected within the 4 hour time period, the Contractor will develop a written implementation schedule for the corrective action and submit the schedule to the Engineer for approval within 1 hour of receiving the written notification. If the schedule is not approved, or if the schedule is approved but is not followed, the Department will adjust the contract according to subsection 812.03.C.1.c.iii. If the implementation schedule is not followed, the Engineer will notify the Contractor and traffic control supplier in writing that they are in violation of this subsection.

c. **Corrective Action.** The Engineer will give written notification to the Contractor as identified above. Failure to make corrections within the timeframe required may result in the following actions by the Engineer:

- i. Stop work on the project until the Contractor completes corrective action,

- ii. Order corrective action by others in accordance with subsection 107.07, subsection 108.02, subsection 812.03.B, and in the interest of public safety.
- iii. A contract price adjustment will be made in the amount of \$100 per hour for every hour or portion thereof the improvements or corrective action remains incomplete as described herein. If improvements or corrections have not been made to the satisfaction of the Department, the contract will be adjusted until the traffic control is acceptable.

MICHIGAN  
DEPARTMENT OF TRANSPORTATION

SPECIAL PROVISION  
FOR  
**PAYMENT FOR MINOR TRAFFIC DEVICES AND TRAFFIC REGULATOR CONTROL**

OPR:JJG

1 of 1

C&amp;T:APPR:BJO:DBP:07-19-11

FHWA:APPR:07-19-11

**Delete Table 812-1 in subsection 812.04.E, on page 625 of the Standard Specifications for Construction, in its entirety and replace with the following.**

**Table 812-1 Partial Payment Schedule for Minor Traf Devices and Traffic Regulator Control**

Percent of Original Contract Amount Earned	Total Percent of Unit Price Paid
First Use	15
25	30
50	55
75	80
90	100

MICHIGAN  
DEPARTMENT OF TRANSPORTATION

SPECIAL PROVISION  
FOR  
**SUPPORTS FOR TEMPORARY SIGNS**

OPR:CRB

1 of 1

C&T:APPR:MWB:DBP:06-26-12

FHWA:APPR:08-18-12

**Delete the last paragraph of subsection 812.03.D.3, on page 604 of the Standard Specifications for Construction in its entirety, and replace with the following.**

Mount construction signs on portable sign support standards only if signs are to remain in place for 14 days or less, or as allowed by the Engineer if fixed supports are not possible.

MICHIGAN  
DEPARTMENT OF TRANSPORTATION

SPECIAL PROVISION  
FOR  
**MEASUREMENT AND PAYMENT OF TEMPORARY TRAFFIC CONTROL DEVICES**

OFS:CRB

1 of 1

APPR:MWB:JJG:02-27-14

FHWA:APPR:03-04-14

**Delete subsection 812.04.A.4, on page 624 of the Standard Specifications for Construction in its entirety.**

**Delete the second paragraph of subsection 812.04.C, on page 624 of the Standard Specifications for Construction in its entirety, and replace with the following:**

The Engineer will measure **Sign, Type \_\_, Temp, Prismatic, Furn** as the total cumulative area of the maximum number of each sign legend that is in use during the course of the project unless previously paid. The unit price for **Sign, Type \_\_, Temp, Prismatic, Furn** includes the cost of portable or driven sign supports.

**Delete the second paragraph of subsection 812.04.D, on page 624 of the Standard Specifications for Construction in its entirety, and replace with the following:**

The Engineer will measure **Sign, Type \_\_, Temp, Prismatic, Oper** as the total cumulative area of the maximum number of each sign legend that is in use during the course of the project unless previously paid.

MICHIGAN  
DEPARTMENT OF TRANSPORTATION

SPECIAL PROVISION  
FOR  
**INDUSTRIAL BY-PRODUCTS AND BENEFICIAL RE-USE**

ENV:HLZ

1 of 1

APPR:JJG:JFS:09-11-14

APPR: FHWA: 09-11-14

**a. Description.** For this project, regardless of the application, the use of industrial by-products, covered in 2014 PA 178, is prohibited unless the use and application of a particular material is covered elsewhere in the contract.

MICHIGAN  
DEPARTMENT OF TRANSPORTATION

SPECIAL PROVISION  
FOR  
**GRANULAR MATERIALS**

C&amp;T:ACR

1 of 1

C&T:APPR:WRE:DBP:10-13-06  
FHWA:APPR:06-01-11

**a. Materials.** Bottom ash may be used for granular material for the pay items Subbase, LM; Subbase, CIP; Embankment, LM and Embankment, CIP. Bottom ash may not be used for any other pay items, unless approved by the Engineer.

The only approved source for furnishing bottom ash as granular material for Subbase, LM; Subbase, CIP; Embankment, LM and Embankment, CIP is the DTE power plant at Monroe.

Provide written documentation to the Engineer that the bottom ash came from DTE's Monroe plant before using the material on the project. All specification requirements for granular materials will remain the same.

MICHIGAN  
DEPARTMENT OF TRANSPORTATION  
SPECIAL PROVISION  
FOR  
**CRUSHED CONCRETE NEAR WATER**

C&amp;T:JFS

1 of 1

C&T:APPR:KAS:DBP:02-24-12  
FHWA:APPR:02-24-12

**Add the following paragraph after the first paragraph of Subsection 902.05 on page 743 of the Standard Specifications for Construction:**

The use of crushed concrete is prohibited on the project within 100 feet of any water course (stream, river, county drain, etc.) and lake, regardless of the application or location of the water course or lake relative to the project limits.

**Add the following paragraph after the first paragraph of Subsection 902.06 on page 743 of the Standard Specifications for Construction:**

The use of crushed concrete is prohibited on the project within 100 feet of any water course (stream, river, county drain, etc.) and lake, regardless of the application or location of the water course or lake relative to the project limits.

**Add the following paragraph after the fourth paragraph of Subsection 902.07 on page 744 of the Standard Specifications for Construction:**

The use of crushed concrete is prohibited on the project within 100 feet of any water course (stream, river, county drain, etc.) and lake, regardless of the application or location of the water course or lake relative to the project limits.



MICHIGAN  
DEPARTMENT OF TRANSPORTATION

SPECIAL PROVISION  
FOR  
**ALTERNATIVE GRANULAR MATERIALS FOR FILL AND SUBBASE**

C&T:ACR

1 of 1

C&T:APPR:JFS:DMG:04-03-12  
FHWA:APPR:04-09-12

**Delete subsection 902.07.A, on page 744, of the Standard Specifications for Construction, in its entirety and replace with the following:**

A. Class I, Class IIAA, or Dense-Graded Aggregate 21A, 21AA and 22A material for Class II material;

**Delete subsection 902.07.B, on page 744, of the Standard Specifications for Construction, in its entirety and replace with the following:**

B. Class I, Class II, Class IIA, Class IIAA, Class IIIA or Dense-Graded Aggregate 21A, 21AA and 22A material for Class III material;

**Delete subsection 902.07.C, on page 744, of the Standard Specifications for Construction, in its entirety and replace with the following:**

C. Class I material for Class IIAA material; and

**Add the following subsection to Section 902.07, on page 744, of the Standard Specifications for Construction.**

D. Dense-Graded Aggregate 21A, 21AA and 22A material for Class IIA.

MICHIGAN  
DEPARTMENT OF TRANSPORTATION

SPECIAL PROVISION  
FOR  
**MICRONIZED COPPER WATER BASED WOOD PRESERVATIVE SYSTEMS**

C&amp;T:SCK

1 of 1

C&T:APPR:KAS:DBP:03-27-12  
FHWA:APPR:05-08-12

**a. Description.** Micronized copper water based wood preservative systems are an alternate to the preservative systems identified in section 912 of the Standard Specifications for Construction, except on wood posts used for signing. Micronized copper water based wood preservative systems are proprietary systems used to treat timber and lumber for resistance to insect attack, decay, and rot. Proprietary micronized copper based wood preservative systems are evaluated by the International Code Council Evaluation Service, Inc (ICC-ES). This special provision covers the requirements for micronized copper azole (MCA) and micronized copper quaternary (MCQ).

**b. Materials.** ICC-ES requirements and specified commercial standards are incorporated herein by reference. Treated wood product reports issued by the ICC-ES as Evaluation Service Reports (ESRs) must be current as posted on the ICC-ES website [www.icc-es.org](http://www.icc-es.org) and in compliance with AC326. The preservative(s) must not contain arsenic. The treated wood product's report must allow for the wood species and end use that is required by the project specifications. The Contractor must provide test data certification for each lot, that the treated timber and lumber meets the retention requirements of the current ESR for the appropriate AWPAs Use Category.

Condition and treat timber and lumber for above ground use to the minimum preservative retention in the ICC-ES evaluation report corresponding to AWPAs Use Category 4A (UC4A). Condition and treat timber and lumber for ground contact to the minimum preservative retention in the ICC-ES evaluation report corresponding to AWPAs Use Category 4B (UC4B).

Condition and treat all round posts, except northern white cedar, to the minimum preservative retention in the ICC-ES evaluation report corresponding to AWPAs Use Category 4B (UC4B).

Incorporation of timber and lumber treated to the preservative retention in AWPAs Use Category 3B (UC3B) or less is not permitted. Timber and lumber placed in violation of this special provision is cause for removal and replacement at the contractor's expense. No pay adjustments will be allowed for incorporation of timber and lumber treated to UC3B preservative retention. Removal is required.

**c. Construction.** Use stainless steel fasteners or hot dipped galvanized fasteners in accordance with ASTM A 653, batch or post-dipped process, with a minimum coating thickness of 1.85 oz of Zinc per square foot of surface area (G185). Do not mix fastener types. Do not use aluminum fasteners. Aluminum must not be in direct contact with treated wood. Non metallic spacers are to be used where contact with aluminum could occur.

**d. Measurement and Payment.** Payment is included in other items of work.

MICHIGAN  
DEPARTMENT OF TRANSPORTATION

NOTICE TO BIDDERS  
FOR  
**MULTIPLE DAVIS-BACON WAGE DECISIONS**

CSD:JDM

1 of 1

APPR:MAS:09-24-14

This proposal may contain multiple Davis-Bacon Wage Decisions. In order to clarify the work covered by each decision, the following explanations are offered:

General Decision MI120001 covers all airport construction, bridge construction, highway construction, and sewer and watermain work that are incidental to highway projects. The construction type indicated on this decision is "HIGHWAY (HIGHWAY, AIRPORT & BRIDGE xxxxx and SEWER/INCID. TO HWY.)". This wage decision is the most commonly used wage decision in MDOT's federally funded projects.

In accordance with the U.S. Department of Labor's All Agency Memorandums No. 130 and No. 131, multiple wage decisions will be included in those projects in which a second category of work is substantial in relation to project cost – more than approximately 20% or \$1,000,000. Sewer and watermain work is considered to fall under the Heavy Construction work classification by the DOL, therefore when that work type is more than 20% of the engineer's estimate or \$1,000,000, the wage decision with the construction type "HEAVY CONSTRUCTION PROJECTS" will also be included in the proposal and is to be used for the sewer and watermain work in the proposal. All other work performed on the project will be covered by the "HIGHWAY (HIGHWAY, AIRPORT & BRIDGE xxxxx and SEWER/INCID. TO HWY.)" wage decision.

Also, when the landscape work is more than 20% of the project cost or \$1,000,000, the "HEAVY CONSTRUCTION PROJECTS" wage decision will be included in the proposal to cover all landscape work. All other work performed on the project will be covered by the "HIGHWAY (HIGHWAY, AIRPORT & BRIDGE xxxxx and SEWER/INCID. TO HWY.)" wage decision. If the project is a total landscape project, only the "HEAVY CONSTRUCTION PROJECTS" wage decision will be in the proposal.

Rest area building projects will include the construction type "BUILDING" wage decision when the building portion of the work is more than 20% of the project cost or \$1,000,000. The other work performed on the project will be covered by the "HIGHWAY (HIGHWAY, AIRPORT & BRIDGE xxxxx and SEWER/INCID. TO HWY.)" wage decision and/or the "HEAVY CONSTRUCTION PROJECTS" wage decision (landscape and/or sewer and watermain work) if either or both are greater than 20% or \$1,000,000.

Although there is only one wage decision for "HIGHWAY (HIGHWAY, AIRPORT & BRIDGE xxxxx and SEWER/INCID. TO HWY.)", work (MI120001), the "HEAVY CONSTRUCTION PROJECTS" and "BUILDING" wage decisions vary from county to county.

**NOTICE TO BIDDERS**

**BID RIGGING**

To report bid rigging activities call:

1-800-424-9071

The U.S. Department of Transportation (DOT) operates the above toll-free "hotline" Monday through Friday, 8:00 a.m. to 5:00 p.m., Eastern Time. Anyone with knowledge of possible bid rigging, bidder collusion, or other fraudulent activities should use the "hotline" to report such activities.

The "hotline" is part of the DOT's continuing effort to identify and investigate highway construction contract fraud and abuse and is operated under the direction of the DOT Inspector General. All information will be treated confidentially and caller anonymity will be respected.

## **NOTICE TO CONTRACTORS/CONSULTANTS**

### **Fraud and Abuse Hotline**

The Michigan Department of Transportation (MDOT) has established a Fraud and Abuse Hotline for employees, contractors, consultants, and others to report suspected fraud or abuse, such as: prevailing wage non-compliance, theft, kickbacks, wrongful claims, contract fraud, use of materials that do not comply with specifications, unapproved substitution of materials, commodities, or test samples, or failure to follow contract procedures.

Anyone with knowledge of any activity involving the potential for fraud or abuse is requested to call the Hotline at (toll free) **1-866-460-6368** or **517-241-2256**.

**MICHIGAN DEPARTMENT OF TRANSPORTATION**

**NOTICE TO BIDDERS**

**ROAD CONSTRUCTION APPRENTICESHIP READINESS (RCAR) PROGRAM**

All bidders are advised of Section 1920(b) of SAFETEA-LU, which states:

“It is the sense of Congress that Federal transportation projects should facilitate and encourage the collaboration between interested persons, including Federal, State, and local governments, community colleges, apprentice programs, local high schools, and other community-based organizations that have an interest in improving the job skills of low-income individuals, to help leverage scarce training and community resources and to help ensure local participation in the building of transportation projects.”

In an effort to improve the job skills of women, minorities and low-income individuals and to help ensure local participation in the building of transportation projects, MDOT and the Department of Labor & Economic Growth in cooperation with local Michigan Works! Agencies have implemented a Road Construction Apprenticeship Readiness (RCAR) program.

The RCAR program, launched in April 2008, is a new and ambitious program designed to equip a diverse pool of Michigan residents with skills for sustainable employment in the road construction industry. The RCAR program included a rigorous, five to six week training component designed to teach and prepare individuals for road construction apprenticeships. In addition to receiving 150 to 180 hours of training in job readiness, applied math, computers, blueprint reading and workplace safety, participants also underwent an entrance assessment, a physical exam and a drug test.

All bidders are hereby informed that a pool of RCAR graduates are available from which to draw potential employees for work on this federal-aid project. RCAR graduates are prescreened, ready to work and can be used to fill MDOT assigned On-the-Job Training slots.

For information regarding RCAR graduates, contact:

## **Metro Region**

Clarence Burton  
Michigan Works!One Stop  
455 W. Fort St.  
Detroit, MI 48226  
(313) 962-9675 Ext. 527  
(313) 962-4884 FAX  
[cburton@detroitmi.gov](mailto:cburton@detroitmi.gov)

Cheryl Sanford  
Michigan HRDI  
13700 Woodward, Highland Park.  
(313) 826-0299.  
(313) 866-1601 FAX  
[csanford@semca.org](mailto:csanford@semca.org)

Robert E. Shimkoski Jr.  
Detroit Workforce Development Department, a Michigan Works! Agency  
707 W. Milwaukee Detroit, MI 48202  
(313) 876-0584 Ext. 217  
(313) 876-0585 FAX  
[Rshimkoski@detroitmi.gov](mailto:Rshimkoski@detroitmi.gov)

## **Southwest Region**

Cincy Sullivan/Fred Harvey/Curt Mastos  
Kalamazoo-St. Joseph Michigan Works! Service Center  
1601 S. Burdick St.  
Kalamazoo MI 49001  
(269) 383-2536 Ext. 117/112/132  
(269) 383-3785 FAX  
[csulliva@kresanet.org](mailto:csulliva@kresanet.org)

## **Bay Region**

Kristen Wenzel  
Saginaw Midland Bay Michigan Works!  
Northpointe Plaza  
4061 North Euclid  
Bay City, MI 48706  
(989) 667-0500  
(989) 684-7920 FAX  
[wenzelk@bst.michiganworks.com](mailto:wenzelk@bst.michiganworks.com)

## **NOTICE TO BIDDERS**

### **BUY AMERICA**

Every effort has been made by the Michigan Department of Transportation to ensure this project can be constructed in accordance with 23CFR635.410 (Buy America). Iron and steel products have been investigated prior to advertising. Items specified in the bidding documents may contain minimal amounts of foreign steel and/or iron that the contractor must consider for Buy America compliance.



**ALLEGAN COUNTY ROAD COMMISSION**

**NOTICE TO BIDDERS**

**UTILITY COORDINATION**

1 of 1

Wightman & Associates, Inc./AJN

8/07/2014

The Contractor shall cooperate and coordinate construction activities with the owners of utilities as stated in Section 104.08 of the 2012 MDOT Standard Specifications for Construction. In addition, for the protection of underground utilities, the Contractor shall follow the requirements in Section 107.12 of the 2012 MDOT Standard Specifications for Construction. Contractor delay claims, resulting from a utility, will be determined based upon Section 109.05.E of the 2012 MDOT Standard Specifications for Construction.

**Public Utilities**

The following Public Utilities have facilities located within the right-of-way:

Electric:                   Great Lakes Energy, 1049 133<sup>rd</sup> Avenue, Wayland, MI 49348  
Mr. Jeff Hicks, (269) 792-0532; 1-888-485-2537 (x 8544)

Telephone:                AT&T, 2919 Millcork Street, Kalamazoo, MI 49001  
Mr. Todd Shibayama, (269) 384-4436

The Contractor shall call "Miss Dig" a minimum of 3 working days prior to beginning construction operations. Saturday, Sundays and Holidays shall not be included as a working day. On all projects:

**"3 Days before you Dig – Call Miss Dig – Toll Free" 811.**

The owners of existing service facilities that are within grading or structure limits will move them to locations designated by the Engineer or will remove them entirely from the highway right-of-way. Owners of the Public Utilities will not be required by the Road Commission to move additional poles or structures in order to facilitate the operation of construction equipment unless it is determined by the Engineer that such poles or structures constitute a hazard to the public or are extraordinarily dangerous to the Contractor's operations.

No additional compensation will be paid to the CONTRACTOR for delays due to material shortages or other reasons beyond the control of the Road Commission, or for delays on construction due to the encountering of existing utilities that are shown on the plans.

Work stoppages by employees of utility companies which results in a delay of utility revisions on any portion of this project may be considered the basis for a claim for an extension of time for completion, but will not be considered the basis for a claim for extra compensation or an adjustment in contract unit prices.

MICHIGAN  
DEPARTMENT OF TRANSPORTATION  
  
SUPPLEMENTAL SPECIFICATION  
FOR  
**ERRATA TO THE 2012 STANDARD SPECIFICATIONS**

1 of 26

09-05-14

Page	Subsection	Errata
3	101.02	Modify the abbreviation reading "AIS" to read "AIS1".
4	101.02	Delete the following abbreviations and the long forms MDELEG MDNRE Add the following abbreviations and the long forms MDNR Michigan Department of Natural Resources MDEQ Michigan Department of Environmental Quality MDLARA Michigan Department of Licensing and Regulatory Affairs NESC National Electrical Safety Code
27	103.02.B.2	Change the last sentence of the first paragraph to read "For decreases below 75 percent, the maximum allowable payment for work performed, including any adjustment, will not exceed an amount equal to 75 percent of the original contract quantity times the contract unit price."
34	104.05	The first sentence of this subsection should read "If the Contractor performs unauthorized work (work performed without the inspections required by the contract, extra work performed without Department approval, work performed contrary to the inspectors direction, or work performed while under suspension by the inspector), the Engineer may reject the unauthorized work."
46	104.12	Add the following to the end of the first paragraph "The use of right-of-way in wetlands and floodplains, or the crossing of water courses by construction equipment is prohibited."
53	105.09	Add the following to the end of the second paragraph "Any specifically produced material not purchased by the Department, will remain the Contractors and must be removed from the project prior to final acceptance."
56	107.02.B.2	This sentence should read "U.S.Army Corps of Engineers' Section 404, Dredge and Fill; and Section 10, Navigable Waterway."
56	107.02.B	Add the subsection reading as follows: "3. U.S. Coast Guard Section 9, Navigable Waterway."

An asterisk (\*) indicates an entry which has been revised from an earlier version of this Supplemental Specification.

Page	Subsection	Errata
		Change "MDNRE" to "MDEQ" in this subsection.
64	107.12	Change the first sentence of the first paragraph to read: "For protection of underground utilities and in accordance with 2013 PA 174, the Contractor must notify Miss Dig at least 3 work days, excluding Saturdays, Sundays and holidays, before beginning each excavation in areas where public utilities have not been previously located."
65	107.15.A	Change "MDNRE" to "MDEQ" in four instances in this subsection.
66	107.15.A.3	Add the following to the end of the paragraph "Note that a burn permit from the MDNR is required for any open burning whenever the ground is not snow covered. Any individuals that allow a fire to escape will be in violation of the Natural Resources and Environmental Protection Act and will be required to reimburse the costs of suppressing the wild fire."
67	107.16	The third sentence should read "In State Forests, the Contractor must contact the local Unit Manager, Forest Management Division, MDNR, regarding the work to be performed within or adjacent to the forest land."  Delete the last sentence of the first paragraph on this subsection.
107	150.04	Change the following pay item reading "Mobilization, Max ___" to read "Mobilization, Max (dollar)" at nine locations throughout the subsection.
112	201.03.A.3.b	Change "MDNRE" to "MDNR" in three instances in this subsection.
150	208.01	Change "MDNRE" to "MDEQ" in this subsection.
188	401.03.H	Change the second sentence of the paragraph to read "Jack steel pipes in place in accordance with subsection 401.03.G".
189	401.03.N	Add the following sentence to the end of the first paragraph "Where possible, maintain the stream flow thru a temporary channel or temporary culvert."  The second sentence of the second paragraph should read "Direct water from the dewatering operations through a filter bag before discharging to an existing drainage facility."
190	401.04	Change the fourth pay item from the end of the list to read as follows: "Steel Casing Pipe, ___ inch, Tr Det ___."
201	402.04.H	Change the last sentence of the first paragraph to read "The Department will not make an adjustment in the pay items of <b>Minor Traffic Devices</b> or <b>Traffic Regulator Control</b> ."

Page	Subsection	Errata
208	403.04.D.3	Change the sentence to read: "Removing and replacing pavement adjacent to the adjusted cover per Standard Plan R-37 Series."
218	406.03.A.2	Change the first sentence of the first paragraph to read: "Design precast box culverts less than 10 feet in span length measured along the centerline of the roadway in accordance with current AASHTO LRFD Bridge Design Specifications and ASTM C 1577."  Add the following sentence to the end of the first paragraph: "Design precast box culverts greater than or equal to 10 feet in span length measured along the centerline of the roadway for HL-93 Modified live load."
219	406.03.B	Change the first sentence of the first paragraph to read: "Submit shop drawings for culverts greater than or equal to 10 feet in span length measured along the centerline of the roadway to the Engineer, for review and approval in accordance with subsection 104.02."
219	406.03.C.1	Change the second sentence of the first paragraph to read: "Before manufacture, perform load ratings on precast three-sided, arch or box culverts greater than or equal to 10 feet in span length measured along the centerline of the roadway, in accordance with the AASHTO Manual of Bridge Evaluation, Section 6, Part A, the Michigan Bridge Analysis Guide current at the time load rating is performed, and the Michigan Structure Inventory and Appraisal Guide."
223	406.03.G	Add the following after the first sentence of the second paragraph: "Where possible, maintain the stream flow thru the existing channel, temporary channel, or temporary culvert."
224	406.03.G	Replace the fifth paragraph of this subsection with the following: "The Contractor may use cast-in-place wing walls, headwalls, and aprons, as alternatives to precast wing walls, headwalls, and aprons. Attach cast-in-place wing walls or headwalls as shown on the shop drawings."
226	406.03.G.2	Change the first sentence of the second paragraph of this subsection to read: "Fill the space between the box culvert joints during placement of box sections with closed-cell rubber extrusion type gaskets in accordance with ASTM C 990."
226	406.04.A.9	Change the sentence to read: "Providing plan modifications including design, additional plan quantities and pay items to accommodate any changes to the precast units as shown on the plans."

Page	Subsection	Errata
226*	406.04.A	Add the following paragraph after the last paragraph of the subsection: "The substructure design is specific to the three-sided or arch culvert detailed on the plans. The Contractor must use approved MDOT service vendors qualified in Hydraulics, Geotechnical Engineering Services, and Short and Medium Span Bridges to perform the required design and plan modifications, as directed by the Engineer, if the Contractor selects a culvert shape different than shown on the plans."
227	406.04.B	Delete the first and second paragraphs following the list of items in this subsection and replace with the following: "The Department will pay separately for cast-in-place concrete, other than for culvert segments, wing walls, and headwalls; excavation; protective coating; providing and placing backfill material; by plan quantity in accordance with subsection 109.01.A."
239	501.03.C.6	The first sentence of this subsection should read "Except as specified in subsection 501.03.C.4, removing HMA surface applies to removing HMA overlying a material designated for removal or that is required to remain in place."
247	501.03.O	Change footnote e in Table 501-5 to read: "Flushing severe enough to significantly affect surface friction (Friction Number <35)."
249	501.04.H	The first sentence of this subsection should read "The Engineer will measure, and the Department will pay for removing HMA surface, no greater than 12 inches thick, overlying a material designated for removal or that is required to remain in place, as <b>HMA Surface, Rem.</b> "  The second paragraph of this subsection should read "The Engineer will measure, and the Department will pay for removing HMA surface, greater than 12 inches thick, overlying a material designated for removal or that is required to remain in place, as <b>Pavt, Rem</b> in accordance with subsection 204.04."
257	503.03.E	Delete this subsection in its entirety.
265	504.03.E.3	Delete this subsection in its entirety.
269	504.04.A	This subsection should read "The unit prices for <b>Micro-Surface</b> , regardless of the type required, include cleaning existing pavement; applying a bond coat; temporary pavement markings; stationing; corrective action; and traffic control to complete corrective action."
308	602.03.F	Note c. in Table 602-1 should read "Refer to Section D6 of the Materials Quality Assurance Procedures Manual for inspection procedure."
320	602.04.C.3	The last paragraph in this subsection should read "If the Engineer approves a substitution of a higher concrete grade for a lesser grade

Page	Subsection	Errata
		(e.g., P1 for P2), the Department will pay for the higher grade of concrete using the original bid and pay items of the lesser grade."
327	603.02	Change the third material in the list to read: "Base Course Aggregate, 4G, 21AA, 22A.....902"
334	603.03.B.10	Change the last sentence of the second paragraph to read "Apply the required curing compound in two coats, at a rate of at least 1 gallon per 25 square yards for each coat."
342	603.04.G.3	Change "D1" to "W" in two instances in this subsection.
351	701.04	Replace Tables 701-1A and 701-1B with the Table 701-1 below.
372	705.03.C.1	Add the following sentence after the first paragraph of this subsection: "Do not drive piles within a radius of 25 feet of newly placed concrete until the concrete attains at least 75 percent of its specified minimum strength."
374	705.03.C.2.c	Change the last sentence of the second paragraph to read "Drive test piles to the minimum pile length or practical refusal, whichever is greater".
379	705.04	Change the fifth item down the list to read: "Pile, Galv (Structure No.)"
380	705.04	Change the last item in the list to read: "Pile Driving Equipment, Furn (Structure No.)"
383	706.02	The fourth paragraph following the list of materials should read "Provide AASHTO M 270, Grade 36 steel, meeting the requirements of ASTM A 786, galvanized in accordance with section 707, for expansion joint cover plates. Provide plates at least 3/8 inch thick. Use plates with a slip resistance equal to or greater than those meeting the requirements of ASTM A 786 and must be approved by the Engineer. Provide ASTM F 593 (Type 304) stainless steel, 3/4-inch or 1/2-inch diameter, flathead countersunk screws with 3/4-inch or 1/2-inch diameter inserts for use in expansion joint cover plates."
389	706.03.D.4.b	Change the first sentence of the fourth paragraph to read "Design forms, form supports, and attachments to carry dead loads, and resultant horizontal loads due to forming of cantilever overhangs."
391	706.03.E.8	Change the first sentence of the second paragraph of this subsection to read: "Patch sawed or sheared ends and visible defects in accordance with ASTM A 775."
392	706.03.E.8	Change the last sentence of the third paragraph of this subsection to read:

Page	Subsection	Errata
		"Coat mechanical splices after splice installation in accordance with ASTM A 775 for patching damaged epoxy coating."
414	707.01.B	Change the last sentence of the first paragraph to read "For horizontally curved or continuous span or cantilevered span girders the Engineer will consider intermediate cross frames and connection plates and stiffeners as primary members."
416	707.03.C.1	Change the title of the subsection from "Shop Plans to read "Shop Drawings".  Change the second sentence of this subsection to read: "Do not use design drawings in lieu of shop drawings."
426	707.03.C.17	Change the second sentence in the first paragraph of this subsection to read: "Tap oversized galvanized nuts in accordance with ASTM A 563 or AASHTO M 292 and meet Supplementary Requirement S1 of ASTM A 563 or AASHTO M 292."
430*	707.03.D.7.b	Change the title of the Table 707-4 to read: "Minimum Bolt Tension for ASTM A 325 Bolts"
430	707.03.D.7.b	Change "104,000" to "103,000" in the last row under the column titled Minimum Bolt Tension.
431	707.03.D.7.c	Change the first sentence of the second paragraph to read: "Do not reuse ASTM A325 bolts and nuts."
434	707.04.A	Change the first sentence of the first paragraph of this subsection to read: "The Engineer will measure structural steel by the calculated weight of metal in the finished structure, excluding filler metal in welding, as shown on the shop drawings or working drawings."
438	708.03.A.2	Change the title of the subsection from "Shop Plans to read "Shop Drawings".  Change the first sentence to read: "Submit shop drawings in accordance with subsection 104.02."  Change the fourth sentence to read: "Do not start production until the Engineer approves the shop drawings."
441*	708.03.A.11	Change the last sentence of the first paragraph to read "Cure concrete at temperatures from 70 °F to 150 °F until concrete attains the release strength shown on the shop drawings".

Page	Subsection	Errata
441	708.03.A.11	Change the fourth sentence of the fourth paragraph to read “Do not exceed a maximum concrete temperature of 150 °F during the curing cycle.”
458	711.03.A	Change the first sentence in the first paragraph to read: “Shop drawings for structural steel and pipe railings are not required.”
460	711.04.A	Change the second sentence of the first paragraph to read: “The unit price for <b>Bridge Barrier Railing</b> includes the cost of placing steel reinforcement, providing and placing concrete, constructing joints, and forming, finishing, curing and protecting the concrete.”
461	711.04.F	The title of this subsection should read " <b>Reflective Marker, Permanent Barrier.</b> "
467	712.03.C	Add the following to the end of the third paragraph of the subsection: “Notify the Engineer of any saw cuts in the top flange. Saw cuts equal to or less than 1/32 inch deep in steel beams must be repaired by grinding, to a surface roughness no greater than 125 micro-inches per inch rms, and tapering to the original surface using a 1:10 slope. Saw cuts in excess of 1/32 inch deep in steel beams require a welded repair to be submitted to the Engineer for approval. Weld in accordance with subsection 707.03.D.8 and provide adequate notice to allow the Engineer to witness the repair work. Inspect and test all saw cut repairs (including grinding repairs) using ultrasonic testing in accordance with 707.03.D.8.c at no additional cost to the Department.”
471	712.03.J.1	Delete the first paragraph in this subsection and replace it with the following: “Propose complete details of drilling, cleaning, and bonding systems for anchoring reinforcement and submit for the Engineer’s approval before use. The minimum embedment depth must be nine times the anchor diameter for threaded rod or bolt and twelve times the anchor diameter for reinforcing bar. Propose a drilling method that does not cut or damage existing reinforcing steel. Prepare at least three proof tests per anchor diameter and type in the same orientation in which they will be installed on the existing structure, on a separate concrete block, in the presence of the Engineer. The Engineer will proof test the proposed systems. The Engineer will base approval of the anchoring system on the following criteria:”
471	712.03.J.2	Change the third sentence of the first paragraph to read: “Use a tension testing device for unconfined testing, in accordance with ASTM E 488.”
473	712.03.L.2	Change the first sentence in the second paragraph of this subsection to read: “If using epoxy coated steel reinforcement, epoxy coat mechanical reinforcement splices in accordance with ASTM A 775.”
473	712.03.L.3	Delete the existing first sentence in the first paragraph.



Page	Subsection	Errata
473	712.03.L.3	Change the third sentence of the first paragraph to read "Provide two test splices on the largest bar size."
473	712.03.L.3	Change the sentence beginning "Demonstrate to the.... to read: "Demonstrate to the Engineer that splices have a tensile strength of 125 percent of the bar yield strength."
488	713.02	Add the following as subsection 713.02.C: "C. <b>Structural Steel for Retrofitting and Welded Repairs.</b> Structural steel material used for retrofitting and welded repairs of primary members as defined in subsection 707.01.B must meet longitudinal Charpy V-Notch impact test requirements."
501	715.02	Add the following material reference above the two existing items: "Sealant for Perimeter of Beam Plates .....713"
508	715.03.D.1	Add the following sentence after the second paragraph of the subsection: "Apply sealant for perimeter of beam plates in accordance with subsection 713.03.F."
519	716.04	Change the second sentence of the first paragraph of this subsection to read: "The unit price for <b>Field Repair of Damaged Coating (Structure No.)</b> includes the costs of making field repairs to the shop applied coating system; prime coat surfaces and exposed surfaces of bolts, nuts, and washers; and repairing stenciling."
521	717.04.B	This subsection should read "The unit price for <b>Drain Casting Assembly</b> includes the cost of providing and installing the downspout and, if necessary, the lower bracket to the drain casting."
522	718.02	Change the section number "906" in the third material in the list to read "919."
533	718.04	Delete the following pay item from the list: Temp Casing.....Foot
533	718.04.B.2	Delete this subsection in its entirety.
533	718.04.B.3	Rename this subsection as follows: "2. <b>Permanent Casing.</b> "
540	802.04	Change "Non reinf" in the last pay item of the list with "Nonreinf".
545*	803.04.E	Change the second sentence of the second paragraph to read: "The unit price for <b>Railing for Steps</b> includes the cost of providing, fabricating, installing, and grouting the railing."

An asterisk (\*) indicates an entry which has been revised from an earlier version of this Supplemental Specification.

Page	Subsection	Errata
560	807.04	Delete the following pay item from the list: Guardrail Buffered End .....Each
567	808.04.C	Change the first paragraph of this subsection to read: "The Department will not pay separately for protective fence required in accordance with subsection 104.07."
569	809.04.A	Change the first sentence to read: "The unit price for <b>Field Office, CI</b> ___ includes the cost of setup, providing access, grading, maintaining, plowing snow, and utility hook-up charges."
570	809.04.B	Delete the existing second and third sentences in the first paragraph and replace them with the following: "The unit price for <b>Field Office, Utility Fees</b> includes the cost of monthly usage fees for electricity, gas, telephone service and charges, fuel for the stove, monthly water and sanitary service."
570	809.04.B	Change the existing fourth sentence in the first paragraph to read: "The Department will reimburse the Contractor for monthly usage fees for electricity, gas, telephone, water and sanitary charges incurred by the Department."
575	810.03.K	Change the subsection to read "K. <b>Drilled Piles for Cantilever and Truss Foundations.</b> Construct drilled piles for cantilever and truss foundations in accordance with section 718."
578	810.03.N.2	Add the following sentence after the first sentence of the second paragraph on this page: "Mark each nut and bolt to reference the required rotation."
584	810.04	Delete the last pay item in the list: Truss Fdn Anchor Bolts, Replace.....Each
596	811.03.G	Delete this subsection in its entirety.
597*	811.03.H	Rename this subsection as follows: "G. <b>Raised Pavement Marker (RPM) Removal.</b> "
597*	811.04	Change "Crosshatching" in the last pay item of the list on this page to "Cross Hatching".
598	811.04	Delete the following pay items from the list: Pavt Mrkg, (material), 4 inch, SRSM, (color).....Foot Pavt Mrkg, (material), 4 inch, SRSM, 2 <sup>nd</sup> Application, (color).....Foot  Add the following pay items to the list: "Pavt Mrkg, Polyurea, (legend).....Each Pavt Mrkg, Polyurea, (symbol).....Each"

Page	Subsection	Errata
		Change the sixth item down the list to read: "Pavt Mrkg, Polyurea, ___ inch, Cross Hatching, (color)"
		Change the eleventh item down the list to read: "Rem Curing Compound, for Longit Mrkg, ___ inch.....Foot"
		Change the last item in the list to read: "Witness, Log, Layout, \$1000.00"
599	811.04.B	Delete this subsection in its entirety.
599	811.04	Rename the following subsections as follows: <b>"B. Call Back.</b> <b>C. Pavement Marking Removal.</b> <b>D. Material Deficiency."</b>
602	812.03.D	Change the first sentence to read "Provide and maintain traffic control devices meeting the requirements in the ATSSA Quality Guidelines for Work Zone Traffic Control Devices and Features."
603	812.03.D.1	The last sentence on this page should read "Lay the sign behind the guardrail, with the uprights pointing downstream from the traffic, and place the support stands and ballasts close to the guardrail."
604	812.03.D.2	The first sentence of the fourth paragraph should read "Do not use burlap or similar material to cover Department or Local Government owned signs."
604	812.03.D.5	The fifth sentence of the first paragraph should read "Do not mix drums and cones within a traffic channeling sequence."
605	812.03.D.6.b	Change the first sentence of the first paragraph to read: "The Department will allow the nighttime use of 42-inch channelizing devices, in the tangent area only, on CPM and pavement marking of any duration where the use of plastic drums restricts proposed lane widths to less than 11 feet, including shy distance."
605	812.03.D.7	Add the following sentence after the first sentence of the first paragraph: "Place a shoulder closure taper in advance of the lighted arrows placed on the shoulders."
607	812.03.D.9	Delete the second paragraph of this subsection and replace with the following: "Link sections together to fully engage the connection between sections. Maintain the barrier with end-attachments engaged and within 2 inches of the alignment shown on the plans."
608	812.03.D.10.b	Add the following sentence after the first paragraph of this subsection:

<b>Page</b>	<b>Subsection</b>	<b>Errata</b>
		“Use an NCHRP 350, Test Level 3, or MASH accepted attenuation system.”
608	812.03.D.10.b	Delete the second sentence of the second paragraph of this subsection beginning with "Install sand module attenuators..."
608	812.03.D.10.b	Add the following sentence after the second paragraph of this subsection: “Install impact attenuation devices as shown on the plans, as directed by the Engineer, or both.”
609	812.03.D.10.d	Add the following sentence after the first paragraph of this subsection: “Use an NCHRP 350, Test Level 3, or MASH accepted attenuation system.”
610	812.03.D.11.a	Change "Type R tape" to read "Type R marking" in three locations in this subsection.
613	812.03.D.14.a.iii	Change the sentence in this subsection to read "Place an ET Type or SKT Type extruder guardrail ending on both blunt guardrail ends."
615	812.03.F	The second sentence of the second paragraph of this subsection should read: "The Contractor may use a Type R temporary pavement marking cover, per subsection 812.03.D.12 when authorized by the Engineer."
616	812.03.F.2	The last sentence of the first paragraph should read: "If the removal equipment cannot collect all removal debris, operate a self-propelled sweeper capable of continuously vacuuming up the removal debris immediately behind the removal equipment."
617	812.03.G.3	The first sentence of the second paragraph should read: "Sweep the shoulder and remove debris prior to placing traffic on the shoulder and throughout the time the shoulder is used to maintain traffic."
617	812.03.G.4.a	Delete "48 inch by 48 inch" from the first sentence of this subsection.
618*	812.03.G.7	The first sentence of the first paragraph should read: "Clean barrier reflectors, plastic drums, 42 inch channelizing devices, tubular markers, signs, barricades, and attached lights in operation on the project to ensure they meet required luminosity."
619	812.03.G.8	The second sentence of the third paragraph from the end of the subsection should read: "Illuminate traffic regulator stations at night per subsection 812.03.H."
621	812.03.I.6	Delete "48 inch by 48 inch" from the second sentence of this subsection.

Page	Subsection	Errata
622*	812.03.J	The second paragraph should read "Apply one 2-inch wide horizontal stripe of red and white conspicuity tape along at least 50 percent of each side of, and across the full width of the rear of the vehicle or equipment."
622	812.04	Change the second item down the list to read: "Traf Regulator Control"
626	812.04.I	Change the reference "812.04.E" in the first sentence to "812.04.D".
628	812.04.M.4	Add the following as the first sentence of this subsection: "The Engineer will not measure a temporary barrier ending move as <b>Conc Barrier Ending, Temp, Relocated</b> if it involves work defined in subsection 812.04.M.3."
629	812.04.N.1	Change the reference "811.04.D" in the second paragraph of this subsection to read "811.04.C".
630	812.04.S	Change the first sentence to read: "The Department will not make additional payments for traffic regulating, signing, arrow boards, and lighting systems for traffic regulator stations operated at night due to a temporary PTS system failure."
634	813.03.C.3	Change the reference "903.07.A" in the paragraph of this subsection to read "907.07.B".
646	815.04	Change the first, third and fourth pay items in the list to read: "Site Preparation, Max (dollar) ..... Lump Sum Watering and Cultivating, First Season, Min (dollar)..... Lump Sum Watering and Cultivating, Second Season, Min (dollar) .....Lump Sum"
646	815.04.C.1	Change the following pay item reading: "Watering and Cultivating, First Season, Min. (dollar)" to read "Watering and Cultivating, First Season, Min (dollar)" at two locations throughout the subsection.
646	815.04.C.2	Change the following pay item reading: "Watering and Cultivating, Second Season, Min. (dollar)" to read "Watering and Cultivating, Second Season, Min (dollar)" at three locations throughout the subsection.
650	816.03.B	Delete the first paragraph of this subsection and replace with the following: "Conduct soil tests when called for in the contract or when directed by the Engineer. Provide soils tests results to the Engineer when testing is required. Provide and place fertilizer as indicated below and as indicated in the soils tests, if required."
650	816.03.B.1	Change the sentence to read: "For Class A fertilizer, evenly apply 176 pounds of chemical fertilizer nutrient per acre on a prepared seed bed."

Page	Subsection	Errata
650	816.03.B.2	Change the sentence to read: "For Class B fertilizer, evenly apply 120 pounds of chemical fertilizer nutrient per acre on a prepared seed bed."
650*	816.03.B.3	Change the sentence to read: "For Class C fertilizer, evenly apply 80 pounds of chemical fertilizer nutrient per acre on established turf."
663	819.01	Change the second sentence of the first paragraph in this subsection to read: "Complete this work in accordance with this section, section 820, and the contract and to the requirements of the NEC, the National Electrical Safety Code, and the MDLARA for those items not identified in the contract."  Change the third sentence of the second paragraph in this subsection to read: "Contact the MDLARA for electrical service inspection and pay the applicable fees."
673	819.03.G.4.b	Change the last sentence of the first paragraph to read: "Tighten the anchor bolts to a snug tight condition as described in the third paragraph of subsection 810.03.N.2 ensuring the lock washer is completely compressed."
673	819.03.G.4.b	Delete the first two sentences of the second paragraph and replace with the following: "Tighten bolts connecting the pole to the frangible base to a snug tight condition. Snug tight is the tightness attained by a few impacts of an impact wrench, or the full effort of a person using an ordinary spud wrench. The lock washers must be fully compressed."
678	819.04	Change the last item in the list on this page to read: "DB Cable, in Conduit, 600 Volt, (number), 1/C# (size).....Foot"
688	820.03.C	Change the seventh paragraph of this subsection to read: "Tighten top anchor bolt nuts, snug, in accordance with the first four paragraphs of subsection 810.03.N.2, except beeswax will not be required."
696	820.04	Add the following pay items to the list: "Pedestal, Pushbutton, Alum.....Each Pedestal, Pushbutton, Rem.....Each"
698	820.04.B	Delete the second paragraph of this subsection found on this page.
698	820.04.C	Change " <b>Fdns</b> " to read " <b>Fdn</b> " in four instances in this subsection.
701	820.04.J.3	Change the sentence to read: "Installing wires in the saw slots and to the handholes;"

Page	Subsection	Errata
701.	820.04.J	Add the following as a new subsection: "7. A 3/4 inch minimum flexible conduit (non-metallic and rated for underground use) from the pavement to the handhole."
706	821.01.B	Change the website address listed after the second paragraph on this page to read: <u>"http://www.ngs.noaa.gov/heightmod/GuidelinesPublications.shtml"</u>
711	822.03.B	Change the second paragraph to read: "If corrugations are required on concrete shoulders and the method of installation is not shown on the plans or directed by the Engineer, construct corrugations by grinding, or cutting."
720	823.04	Change the pay item seventh from the bottom of the list to read: "Water Shutoff, Adj, Temp, Case ___"
732	824.04	Change the first sentence of the first paragraph following the list of pay items to read: "If the Engineer determines the Contractor will perform staking as extra work, the Department will pay for staking in accordance with section 103."
733	824.04	Change the left column header in Table 824-2 to read: <b>"Percent of Original Contract Amount Earned"</b>
739	902.02	Change the last aggregate testing description to read: "Determining Specific Gravity and Absorption of Fine Aggregates.....MTM 321"
742	902.03.C.1.a	Change the sentence to read: "Coarse aggregate includes all aggregate particles greater than or retained on the 3/4-inch sieve."
742	902.03.C.2.a	Change the sentence to read: "Intermediate aggregate includes all aggregate particles passing the 3/4-inch sieve through those retained on the No. 4 sieve."
746*	902.11	Change the Item of Work by Section Number column in Table 902-1 for the 6AA row to read: "406, 601, 602, 706, 708, 806".  Change the Item of Work by Section Number column in Table 902-1 for the 6A row to read: "206, 401, 402, 406, 601, 602, 603, 706, 806".  Change the Item of Work by Section Number column in Table 902-1 for the 34R row to read: "401, 404, 406".
751*	902.11	Replace Table 902-6 with the Table 902-6 below.

An asterisk (\*) indicates an entry which has been revised from an earlier version of this Supplemental Specification.

<b>Page</b>	<b>Subsection</b>	<b>Errata</b>
751	Table 902-7	Under the Material column in the fourth row change the "FA2" to read "2FA".
751	Table 902-7	Under the Material column in the fifth row change the "FA3" to read "3FA".
752	Table 902-8	Under the Material column in the fourth row change the "FA2" to read "2FA".
752	Table 902-8	Under the Material column in the fifth row change the "FA3" to read "3FA".
761	Table 904-2	Delete the footnote f and any other reference to footnote f from the table.
767	905.03	Change the first sentence of the first paragraph to read: "Deformed bars, must meet the requirements of ASTM A 706, ASTM A 615, or ASTM A 996 (Type R or Type A only) for Grade 60 steel bars, unless otherwise required".
767*	905.03	Change the first sentence of the second paragraph to read: "Unless otherwise specified, spiral reinforcement must meet the requirements of plain or deformed Grade 40 steel bars of ASTM A 615, ASTM A 996 (Type A), or the requirements of cold-drawn wire of ASTM A 1064".
767	905.03	Change the first sentence of the third paragraph to read: "Bar reinforcement for prestressed concrete beams must meet the requirements of ASTM A 996 (Type R) for Grade 60 steel bars, except the Engineer will allow bar reinforcement that meets the requirements of ASTM A 615 or ASTM A 996 (Type A) for Grade 40 steel bars for stirrups in prestressed concrete beams".
768	905.03.C	Change the first sentence in the subsection to read: "Epoxy coated steel reinforcement, if required, must be coated in accordance with ASTM A 775, with the following exceptions and additions."
768	905.03.C.3	Change the first sentence of this subsection to read: "Include written certification that the coated reinforcing bars were cleaned, coated, and tested in accordance with ASTM A 775 with the coating applicator."
768	905.05	Change the first sentence of the first paragraph to read: "Deformed steel bars must meet the requirements of ASTM A 706 or the requirements for Grade 40, Grade 50, or Grade 60 of ASTM A 615 or ASTM A 996 (Type R or Type A only)".
768	905.06	Delete this subsection in its entirety and replace it with the following:



Page	Subsection	Errata
		"Deformed wire fabric for prestressed concrete and fabric for concrete pavement reinforcement must meet the requirements of ASTM A 1064 and fabricated as required."
772	906.07	<p>Change the first paragraph to read:            "High-strength bolt fasteners for structural joints must meet the requirements of ASTM A 325 Type 1 bolts. High-strength nuts for structural joints must meet the requirements of ASTM A 563 Grade DH or AASHTO M 292 Grade 2H. High-strength washers for structural joints must meet the requirements of ASTM F 436 Type 1 for circular, beveled, clipped circular, and clipped beveled washers."</p> <p>Change the second sentence of the second paragraph of this subsection to read:            "Galvanized nuts must be tapped oversize in accordance with ASTM A 563 and meet Supplementary Requirements S1, Lubricant and Rotational Capacity Test for Coated Nuts and S2, Lubricant Dye."</p>
772	906.08	Change the last sentence of the first paragraph to read "Washers must be made from austenitic stainless steel ASTM A 276 UNS designation S31600 or S31603."
777*	907.03.D.2.a	Change the first sentence of the second paragraph to read: "Angle sections must be nominal 2½ inch by 2½ inch by ¼ inch."
777*	907.03.D.2.b	Change the first sentence of the first paragraph to read: "Angle section braces must be nominal 1¾ inch by 1¾ inch by ¼ inch or nominal 2 inch by 2 inch <sup>3</sup> / <sub>16</sub> inch."
782	908.04	Change the first sentence of the first paragraph of this subsection to read: "Steel castings for steel construction must meet the requirements of ASTM A 148 for Grade 60/90 carbon steel castings, as shown on the plans, unless the Engineer approves an alternate in writing."
783	908.09.A	Change the title of this subsection and the first sentence to read <b>"A. Base Plates, Angle, and Non-Tubular Post Elements.</b> Galvanized base plates, angle, rail splice elements, and non-tubular post elements must meet the requirements of ASTM A 36 and ASTM A 123".
783	908.09.B	Change the title of this subsection and the first sentence to read <b>"B. Rail Elements and Tubular Post Elements.</b> Rail elements and tubular post elements must meet the requirements of ASTM A 500, for Grade B and subsection 908.09.B and be galvanized in accordance with ASTM A 123".
784	908.09.C	Change the second sentence to read: "Heavy hex nuts must meet the requirements of ASTM A 563."

Page	Subsection	Errata
		<p>Change the third sentence to read: "Bolts, used as rail fasteners, washers and nuts must meet the requirements of ASTM A 325, Type 1."</p> <p>Change the sixth sentence to read: "All flat washers must meet the requirements of ASTM F 436."</p> <p>Add the following sentence to the end of the subsection: "Bolts, nuts, washers and other hardware must be hot-dip galvanized in accordance with AASHTO M 232."</p>
785	908.11.B	<p>Change the second paragraph to read: "Bolts, nuts, and round washers for guardrail, other than at bridge barrier railings, must meet the requirements of ASTM A 307, ASTM A 563 (Grade A with Supplementary Requirements S1 of ASTM A 563), and ASTM F 436, respectively."</p> <p>Change the third paragraph to read: "Washers, other than round washers, for guardrail must meet the requirements for circular washers in ASTM F 436 except that the dimensions must be as shown on the plans."</p> <p>Change the fifth paragraph to read: "Bolts, nuts, and washers for connections at bridge barrier railings must conform to ASTM A 325 Type 1 galvanized high-strength structural bolts with suitable nuts and hardened washers."</p>
787	908.14.B	<p>Add the following sentence to the end of the third paragraph of this subsection: "Exposed threaded ends of anchor bolts must be galvanized a minimum of 20 inches."</p> <p>Change the sixth paragraph in this subsection to read: "Provide washers meeting the requirements of ASTM F 436 for circular washers."</p>
787	908.14.B	<p>Change the second sentence of the fourth paragraph to read "After coating, the maximum limit of pitch and major diameter for bolts with a diameter no greater than 1 inch may exceed the Class 2A limit by no greater than 0.021 inch, and by no greater than 0.031 inch for bolts greater than 1 inch in diameter".</p>
787*	908.14.C	<p>Change the first paragraph to read "Provide either four or six high strength anchor bolts per the contract plans, meeting the mechanical requirements of ASTM F 1554, for Grade 105, with each standard. Anchor bolts for traffic signal strain poles must meet the requirements of subsection 908.14.B with the following exceptions and additions:"</p>
789	909.03	<p>Change the second sentence of the second paragraph to read:</p>

Page	Subsection	Errata
		"As an alternative to the AASHTO M 36 requirements for metal pipe, the Contractor may use gasket material meeting the low temperature flexibility and elevated temperature flow test requirements of ASTM C 990, excluding the requirements for softening point, flashpoint and fire point."
793	909.06	Change the first sentence of the second paragraph of this subsection to read: "Provide Corrugated Polyvinyl Chloride Pipe (CPV) and required fittings meeting the requirements of AASHTO M 304."
793*	909.05.D	Change the second sentence of the paragraph to read "Provide a continuous welded joint to create a watertight casing that is capable of withstanding handling and installation stresses. Perform field welding by the SMAW process using E7018 electrodes."
794*	909.08.A	Change the first sentence to read: "Provide bridge deck downspouts of PE pipe meeting the requirements of ASTM F 714, PE 4710, DR 26."
804	Table 909-9	In the note area at the bottom of the table change the designation of the second note from "c." to "b."
811	910.04	Add the following sentence to the end of this subsection: "Fabricate silt fence according to subsection 916.02."
829*	912.08.K	Replace Table 912-10 with the Table 912-10 below.
833	913.03.B	Change the first sentence of the first paragraph to read: "Clay brick, to construct manholes, catch basins, and similar structures, must meet the requirements of ASTM C32, for Grade MS."
837	914.04	Add the following as subsection 914.04.C: "C. Lubricant-Adhesive for Neoprene Joint Seals. The lubricant-adhesive must be a single-component moisture-curing polyurethane and aromatic hydrocarbon solvent mixture meeting ASTM D 2835, Type I. Ship in containers plainly marked with the lot or batch number of the material and date of manufacture. Store at temperatures between 58 and 80°F. Do not exceed 12 months shelf-life prior to use."
840	914.08	Change the first sentence of the second paragraph to read: "Straight tie bars for end-of-pour joints must consist of bars of the diameter and length shown on the plans meeting the requirements of ASTM A 615, ASTM A 706, or ASTM A 996 (Type R or Type A only)".
840	914.09.A	Change the first sentence of the first paragraph to read: "Straight tie bars for longitudinal pavement joints must consist of bars of the diameter and length shown on the plans meeting the requirements of ASTM A 615, ASTM A706, or ASTM A 996 (Type R or Type A only)".

Page	Subsection	Errata
840	914.09.B	Change the first sentence of the first paragraph to read: "Bent tie bars for bulkhead joints must consist of bars of the diameter and length shown on the plans."
841	914.12	In the first sentence of this subsection change "AASHTO Division II" to read "AASHTO LRFD Bridge Construction Specifications".
841*	914.13	In the first sentence of this subsection change "ASTM D 1248, for Type III, Class B" to read "ASTM D 4976, Group 2, Class 4, Grade 4".
844	916.01.A	Change the first sentence to read: "Cobblestone must consist of rounded or semi-rounded rock fragments with an average dimension from 3 inches to 10 inches."
845	916.01.D.1	Change the second sentence to read: "Checkdams for ditch grades 2 percent or greater must be constructed using cobblestone or broken concrete ranging from 3 inches to 10 inches in size."
851*	917.10.B.1	Delete the paragraph and replace it with the following: "1. <b>Class A.</b> Provide and apply Class A chemical nutrient fertilizer either according to MSU Soil Testing Lab Recommendations for Phosphorus Applications to Turfgrass, except the maximum single application rate of nutrient will be 48 pounds per acre, when soil tests are required or as indicated in subsections 917.10.B.1.a and 917.10.B.1.b."
851	917.10.B.1	Add the MSU Soil Testing Lab Recommendations for Phosphorus Applications to Turfgrass, found below, after the first paragraph of this subsection.
853	917.15.B.1	Change the second sentence of the subsection to read: "The net must meet the requirements of subsection 917.15.D and be capable of reinforcing the blanket to prevent damage during shipping, handling, and installation."
857	918.01	Add the following two paragraphs following the first paragraph of this subsection: "Wall thickness and outside diameter dimensions must conform to ASTM D 1785 for smooth-wall schedule 40 and 80 PVC conduit material. The Department will allow no more than 3 percent deviation from the minimum wall thickness specified.  Wall thickness range must be within 12 percent in accordance with ASTM D 3035 for smooth-wall coilable schedule 40 and 80 PE conduit."
858	918.01.E	Delete the first three sentences of the second paragraph shown on page 858.

<b>Page</b>	<b>Subsection</b>	<b>Errata</b>
863	918.06.F.1	Delete the third paragraph in this subsection in its entirety and replace it with the following: "Provide smooth or deformed welded wire fabric in accordance with ASTM A 1064."
864	918.07.C	Change the first sentence of the first paragraph to read: "Provide anchor bolts, nuts, and washers meeting the requirements of subsection 908.14.A and subsection 908.14.B."
864	918.07.C	Delete the second sentence of the second paragraph.
864	918.07.C	Change the third sentence to read: "Provide anchor bolts threaded 4 inches beyond the anchor bolt projection shown on the plans."
867	918.08.C	Change the last sentence of the first paragraph on this page to read: "Galvanize bolts, nuts, washers, and lock washers as specified in subsection 908.14.B."
867	918.08.C	Change the last sentence of the subsection to read: "Provide each frangible base with manufacturer access covers as shown on the plans."
867*	918.08.D	Delete this subsection in its entirety and replace with the following: "Provide galvanized anchor bolts, studs, nuts, couplings, and washers in accordance with subsection 908.14."
879	918.10.J	Change the third sentence of the second paragraph of this subsection to read: "Provide anchor bolts and associated nuts, washers, and hardware meeting the requirements of subsection 908.14."
903	921.03.D	Delete the last three sentences of the first paragraph of this subsection.
914	921.05.D	Change the first sentence of this subsection to read: "Provide anchor bolts meeting the requirements of subsection 908.14.C, including elongation and reduction of area requirements."
916	921.07	Change the first sentence of the first paragraph to read: "Provide LED case signs internally illuminated by LEDs and changeable message case signs internally illuminated with LED light sources."
936	922.04.B	In the first sentence of the first paragraph change the "R-52" to "R-126".
936	922.04.B	Add the following to the end of the first paragraph: "Hardware used to connect the end section to the barrier must meet the requirements of NCHRP 350 or MASH (Test Level 3 or higher)."

Page	Subsection	Errata		
936	922.04.B	In the first sentence of the second paragraph delete "R-52".		
953	Pay Item Index	Change the following pay item to read: "DB Cable, in Conduit, 600 Volt, (number), 1/C# (size).....	678	819"
957	Pay Item Index	Delete the following pay item from the list: Guardrail Buffered End .....	560	807
960	Pay Item Index	Change the following pay item to read: "Mobilization, Max (dollar).....	107	150"
961	Pay item Index	Delete the following pay items from the list: Pavt Mrkg, (material), 4 inch, SRSM, (color)..... Pavt Mrkg, (material), 4 inch, SRSM, 2 <sup>nd</sup> Application, (color).....	598..... 598.....	811 811
961	Pay Item Index	Change the following pay items in the list to read: Pavt Mrkg, Ovly Cold Plastic, 12 inch, Cross Hatching, (color) Pavt Mrkg, Polyurea, __ inch, Cross Hatching, (color)  Add the following pay items to the list: "Pavt Mrkg, Polyurea, (legend)..... Pavt Mrkg, Polyurea, (symbol)..... Pedestal, Pushbutton, Alum..... Pedestal, Pushbutton, Rem.....	598..... 598..... 696..... 696.....	811 811 820 820"
962	Pay Item Index	Change the following pay items in the list to read: "Pile Driving Equipment, Furn (Structure No.) Pile, Galv (Structure No.)"		
963	Pay Item Index	Change the following pay item to read: "Rem Curing Compound, for Longit Mrkg, __ inch .....	598	811"
965	Pay Item Index	Change the following pay item in the list to read: "Steel Casing Pipe, __ inch, Tr Det __ Site Preparation, Max (dollar) .....	646	815"
966	Pay Item Index	Delete the following pay item form the list; Temp Casing.....	533.....	718
967	Pay Item Index	Delete the following pay item form the list; Truss Fdn Anchor Bolts, Replace.....	584.....	810
967	Pay Item Index	Change the following pay item in the list to read: "Traf Regulator Control"		
968	Pay item Index	Change the following pay item in the list to read: "Water Shutoff, Adj, Temp, Case __ Watering and Cultivating, First Season, Min (dollar)..... Watering and Cultivating, Second Season, Min (dollar) .....	646 646	815 815"

An asterisk (\*) indicates an entry which has been revised from an earlier version of this Supplemental Specification.

<b>Page</b>	<b>Subsection</b>	<b>Errata</b>
969	Pay item Index	Change the following pay item in the list to read: "Witness, Log, Layout, \$1000.00"
993	General Index	Change "Shop Plans (see Plans and Working Drawings)" to read "Shop Drawings (see Plans and Working Drawings)".

Table 701-1 Concrete Structure Mixtures													
		Slump (inches)				Minimum Strength of Concrete (f)							
Concrete Grade (e,h)	Section Number Reference (i)	Cement Content per cyd (b,c)		Type A, D or no Admixture	Type MR, F, or G Admixtures (g)			Flexural (psi)			Compressive (psi)		
		lb	sack		Before Admixture	After Admixture (Type MR)	After Admixture (Type F or G)	7 Day	14 Day	28 Day (Class Design Strength)	7 Day	14 Day	28 Day (Class Design Strength)
D (a)	706, 711, 712	658 (d)	7.0	0 - 3	0 - 3	0 - 6	0 - 7	625	700	725	3,200	4,000	4,500
S1	705	611	6.5	3 - 5	0 - 3	3 - 6	3 - 7	600	650	700	3,000	3,500	4,000
T	705, 706	611	6.5	3 - 7	0 - 4	3 - 7	3 - 8	550	600	650	2,600	3,000	3,500
S2 (a)	401, 705, 706, 712, 713, 801, 802, 803, 810	564	6.0	0 - 3	0 - 3	0 - 6	0 - 7	550	600	650	2,600	3,000	3,500
		526 (d)	5.6										
S3	402, 403, 803, 804, 806	517	5.5	0 - 3	0 - 3	0 - 6	0 - 7	500	550	600	2,200	2,600	3,000
		489 (d)	5.2										

a. Unless otherwise required, use Coarse Aggregate 6AA or 17A for exposed structural concrete in bridges, retaining walls, and pump stations.

b. Do not place concrete mixtures containing supplemental cementitious materials unless the local average minimum temperature for the next 10 consecutive days is forecast to be above 40 °F. Adjustments to the time required for opening to construction or vehicular traffic may be necessary. Cold weather protection may be required, as described in the quality control plan. The restriction does not apply to Grade S1 concrete in foundation piling below ground level or Grade T concrete in tremie construction.

c. Type III cement is not permitted

d. Use admixture quantities specified by the Qualified Products Lists to reduce mixing water. Admixture use is required for Grade D, Grade S2, and Grade S3, concrete with a reduced cement content. Use a water-reducing retarding admixture at the required dosage for Grade D concrete to provide the setting retardation required. When the maximum air temperature is not forecast to exceed 60 °F for the day, the Contractor may use a water-reducing admixture or a water-reducing retarding admixture. Ensure Grade D concrete in concrete diaphragms contains a water-reducing admixture, or a water-reducing retarding admixture. For night casting, the Contractor may use a water-reducing admixture in lieu of water-reducing retarding admixture, provided that the concrete can be placed and finished prior to initial set.

e. The mix design basis for bulk volume (dry, loose) of coarse aggregate per unit volume of concrete is 68% for Grade S1, and 70% for Grade D, Grade S2, Grade T, and Grade S3.

f. The Contractor may use flexural strength to determine form removal. Use compressive strength for acceptance in other situations.

g. MR = Mid-range.

h. The Engineer will allow the use of an optimized aggregate gradation as specified in section 604.

i. Section Number Reference:

401	Culverts	711	Bridge Railings	803	Concrete Sidewalk, Sidewalk Ramps, and Steps
402	Storm Sewers	712	Bridge Rehabilitation-Concrete	804	Concrete Barriers and Glare Screens
403	Drainage Structures	713	Bridge Rehabilitation-Steel	806	Bicycle Paths
705	Foundation Piling	801	Concrete Driveways	810	Permanent Traffic Signs and Supports
706	Structural Concrete Construction	802	Concrete Curb, Gutter and Dividers		

An asterisk (\*) indicates an entry which has been revised from an earlier version of this Supplemental Specification.



**Table 902-6  
Superpave Final Aggregate Blend Physical Requirements**

Est. Traffic (million ESAL)	Mix Type	Percent Crushed Minimum Criteria		Fine Aggregate Angularity Minimum Criteria		% Sand Equivalent Minimum Criteria		Los Angeles Abrasion % Loss Maximum Criteria		% Soft Particles Maximum Criteria (b)		% Flat and Elongated Particles Maximum Criteria (c)	
		Top & Leveling Courses	Base Course	Top & Leveling Courses	Base Course	Top & Leveling Courses	Base Course	Top & Leveling Courses	Base Course	Top & Leveling Courses	Base Course	Top & Leveling Courses	Base Course
< 0.3	LVSP	55/—	—	—	—	40	40	45	45	10	10	—	—
< 0.3	E03	55/—	—	—	—	40	40	45	45	10	10	—	—
≥0.3 - <1.0	E1	65/—	—	40	—	40	40	40	45	10	10	—	—
≥1.0 - < 3	E3	75/—	50/—	40(a)	40(a)	40	40	35	40	5	5	10	10
≥3 - <10	E10	85/80	60/—	45	40	45	45	35	40	5	5	10	10
≥10 - <30	E30	95/90	80/75	45	40	45	45	35	35	3	4.5	10	10
≥30 - <100	E50	100/10 0	95/90	45	45	50	50	35	35	3	4.5	10	10

- (a) For an E3 mixture type that enters the restricted zone as defined in Table 902-5, the minimum is 43. If these criteria are satisfied, acceptance criteria and associated incentive/disincentive or pay adjustment tied to this gradation restricted zone requirement included in contract, do not apply. Otherwise, final gradation blend must be outside of the restricted zone.
- (b) Soft particles maximum is the sum of the shale, siltstone, ochre, coal, clay-ironstone and particles that are structurally weak or are non-durable in service.
- (c) Maximum by weight with a 1 to 5 aspect ratio.

Note: "85/80" denotes that 85 percent of the coarse aggregate has one fractured face and 80 percent has at least two fractured faces.

An asterisk (\*) indicates an entry which has been revised from an earlier version of this Supplemental Specification.

<b>Table 912-10 Minimum Retention Requirements</b>				
<b>Preservative</b>	<b>Minimum Retention, (pcf)</b>			<b>AWPA Standard</b>
	<b>Guardrail Posts</b>	<b>Sign Posts</b>	<b>Blocks</b>	
Pentachlorophenol	0.60	0.50	0.40	A6
CCA, ACZA	0.60	0.50	0.40	A11
ACQ (a)	0.60	Not Allowed	0.40	A11
CA-B (a)	0.31	Not Allowed	0.21	A11
CA-A (a)	0.31	Not Allowed	0.15	A11
Other Waterborne preservatives	AWPA Commodity Specification A, Table 3.0, Use Category 4B	Not Allowed	AWPA Commodity Specification A, Table 3.0, Use Category 4A	A11
a. Non-Metallic washers or spacers are required for timber and lumber treated with ACQ or CA placed in direct contact with aluminum. Do not use with sign posts.				

MSU Soil Testing Lab Recommendations for Phosphorus Applications to Turfgrass  
3/8/2012

		Sand based rootzone establishment	Golf greens and tees est. or mature; Kentucky bluegrass or perennial ryegrass athletic fields est. or mature; sand based rootzone mature	Lawns, golf course fairways; establishment or mature	Establishment without soil test
Bray P1, Mehlich 3 Soil Test Value (ppm): pH<7.4	Olsen Soil Test Value (ppm) pH>7.4	Recommendation (lbs. P <sub>2</sub> O <sub>5</sub> /1000 ft. <sup>2</sup> )	Recommendation (lbs. P <sub>2</sub> O <sub>5</sub> /1000 ft. <sup>2</sup> )	Recommendation (lbs. P <sub>2</sub> O <sub>5</sub> /1000 ft. <sup>2</sup> )	Recommendation (lbs. P <sub>2</sub> O <sub>5</sub> /1000 ft. <sup>2</sup> )
0	0	4.4	3.4	2.5	2.5 lbs. year (Maximum single application of 1.5 lbs.)
2	1.3	4.1	3.1	2.2	
4	2.7	3.9	2.7	1.9	
6	4	3.6	2.4	1.6	
8	5.3	3.4	2.0	1.3	
10	6.7	3.1	1.7	1.0	
12	8	2.8	1.4	0.7	
14	9.3	2.6	1.0	0.4	
16	10.7	2.3	0.7	0.1	
18	12	2.1	0.3	0.0	
20	13.3	1.8	0.0		
22	14.7	1.5			
24	16	1.3			
26	17.3	1.0			
28	18.7	0.8			
30	20	0.5			
32	21.3	0.2			
34	22.7	0.0			

Web resources: [www.turf.msu.edu](http://www.turf.msu.edu) or [www.bephosphorusmart.msu.edu](http://www.bephosphorusmart.msu.edu)

## NOTICE TO BIDDERS – INQUIRY

All inquiries concerning the plans and proposal for this project are to be directed to:

Lynnette Firman

\_\_\_\_\_  
Name

Urban Staff Engineer

\_\_\_\_\_  
Title

firmanl@michigan.gov

\_\_\_\_\_  
E-mail Address

517-335-2224

\_\_\_\_\_  
Phone

**All inquiries must be made by E-mail through the electronic proposal system at MDOT's e-Proposal website – [www.michigan.gov/mdot-eprop](http://www.michigan.gov/mdot-eprop).** Telephone inquiries will not be answered. To be able to process and distribute an addendum, if required, all inquiries shall be made at least seven (7) calendar days before the letting. Inquiries made after this date will be considered by MDOT, but will not require a response.

Inquiries made by E-mail must include the following information:

Proposal Item Number

Contract ID

Name of Inquiring Person

Company Name

Phone # and E-mail address

Detailed question(s) with reference to proposal page and plan sheet number

Other employees of MDOT have been instructed to direct all inquiries to the person mentioned above.

2/11/2009

Job(s): 119603A

**APPENDIX A**  
**PROHIBITION OF DISCRIMINATION IN STATE CONTRACTS**

In connection with the performance of work under this contract; the contractor agrees as follows:

1. In accordance with Act. No. 453, Public Acts of 1976, the contractor hereby agrees not to discriminate against an employee or applicant for employment with respect to hire, tenure, terms, conditions, or privileges of employment, or a matter directly or indirectly related to employment, because of race, color, religion, national origin, age, sex, height, weight, or marital status. Further, in accordance with Act No. 220, Public Acts of 1976 as amended by Act No. 478, Public Acts of 1980, the contractor hereby agrees not to discriminate against an employee or applicant for employment tenure, terms, conditions, or privileges of employment, or a matter directly or indirectly related to employment, because of a disability that is unrelated to the individual's ability to perform the duties of a particular job or position. A breach of the above covenants shall be regarded as a material breach of this contract.
2. The contractor hereby agrees that any and all subcontractors to this contract, whereby a portion of the work set forth in this contract is to be performed, shall contain a covenant the same as in herein before set forth in section 1 of this Appendix.
3. The contractor will take affirmative action to insure that applicants for employment and employees are treated without regard to their race, color, religion, national origin, sex, height, weight, marital status or disability that is unrelated to the individual's ability to perform the duties of a particular job or position. Such action shall include, but not be limited to the following; employment, upgrading, demotion or transfer, recruitment advertising; layoff or termination; rates of pay or other forms of compensation; and selection for training, including apprenticeship.
4. The contractor will, in all solicitations or advertisements for employees placed by or on behalf of the contractor, state that all qualified applicants will receive consideration for employment without regard to race, color, religion, national origin, age, sex, height, marital status or disability that is unrelated to the individuals ability to perform the duties of a particular job or position.
5. The contractor or his collective bargaining representative will send to each labor union or representative of workers with which he has a collective bargaining agreement or other contract or understanding, a notice advising the said labor union or workers' representative of the contractor's commitments under this appendix.
6. The contractor will comply with relevant published rules, regulations, directives, and orders of the Michigan Civil Rights Commission which may be in effect prior to the taking of bids for any individual state project.
7. The contractor will furnish and file compliance reports within such time and upon such forms as provided by the Michigan Civil Rights Commission, said forms may also elicit information as to the practices, policies, program and employment statistics of each subcontractor as well as the contractor himself, and said contractor will permit access to his books, records, and accounts by the Michigan Civil Rights Commission, and/or its agent, for purposes of investigation to ascertain compliance with this contract and relevant with rules, regulations, and orders of the Michigan Civil Rights Commission.
8. In the event that the Civil Rights Commission finds, after a hearing held pursuant to its rules, that a contractor has not complied with the contractual obligations under this agreement, the Civil Rights Commission may, as a part of its order based upon such findings, certify said findings to the Administrative Board of the State of Michigan, which Administrative Board may order the cancellation of the contract found to have been violated, and/or declare the contractor ineligible for future contracts with the state and its political and civil subdivisions, departments, and officers, and including the governing boards of institutions of higher education, until the contractor complies with all of the persons with whom the contractor is declared ineligible to contract as a contracting party in future contracts. In any case before the Civil Rights Commission in which cancellation of an exiting contract is a possibility, the contracting agency shall be notified of such possible remedy and shall be given the option by the Civil Rights Commission to participate in such proceedings.
9. The contractor will include, or incorporate by reference, the provisions of the forgoing paragraphs (1) through (8) in every subcontract or purchase order unless exempted by rules, regulations or orders of the Michigan Civil Rights Commission, and will provide in every subcontract or purchase order that said provisions will be binding upon each subcontractor or seller.

*\*The Civil Rights Commission referred to as the Michigan Civil Rights Commission*

## TITLE VI ASSURANCE

### APPENDIX C

During the performance of this contract, the contractor, for itself, its assignees and successors in interest (hereinafter referred to as the “contractor”) agrees as follows:

1. **Compliance with Regulations:** The contractor shall comply with the Regulations relative to nondiscrimination in Federally-assisted programs of the Department of Transportation, Title 49, code of Federal Regulations, Part 21, as they may be amended from time to time, (hereinafter referred to as the Regulations), which are herein incorporated by reference and made a part of this contract.
2. **Nondiscrimination:** The contractor, with regard to the work performed by it during the contract, shall not discriminate on the grounds of race, color, national origin, sex, age, or disability in the selection and retention of subcontractors, including procurements of materials and leases of equipment. The contractor shall not participate either directly or indirectly in the discrimination prohibited by section 21.5 of the Regulation, including employment practices when the contractor covers a program set forth in Appendix B of the Regulations.
3. **Solicitations for Subcontracts, Including Procurements of Materials and Equipment:** In all solicitations either by competitive bidding or negotiation made by the contractor for work to be performed under a subcontract, including procurements of materials or leases of equipment, each potential subcontractor or supplier shall be notified by the contractor of the contractor’s obligations under the contract and the Regulations relative to nondiscrimination on the grounds of race, color, national origin, sex, age, or disability.
4. **Information and Reports:** The contractor shall provide all information and reports required by the Regulations, or directives issued pursuant thereto, and shall permit access to its books, records, accounts, other sources of information, and its facilities as may be determined by the State Highway department of the Federal Highway Administration to be pertinent to ascertain compliance with such Regulations or directives. Where any information required of a contractor is in the exclusive possession of another who fails or refuses to furnish this information, the contractor shall so certify to the State highway department, or the Federal Highway Administration as appropriate, and shall set forth what efforts it has made to obtain the information.
5. **Sanctions for Noncompliance:** In the event of the contractor’s noncompliance with the nondiscrimination provisions of this contract, the State highway department shall impose such contract sanctions as it or the Federal Highway Administration may determine to be appropriate, including, but not limited to:
  - (a) withholding of payments to the contractor under the contract until the contractor complies, and/or
  - (b) cancellation, termination or suspension of the contract, in whole or in part.
6. **Incorporation of Provisions:** The contractor shall include the provisions of paragraphs (1) through (6) in every subcontract, including procurement of materials and leases of equipment, unless exempt by the Regulations, or directives issued pursuant thereto. The contractor shall take such action with respect to any subcontract or procurement as the State highway department or the Federal Highway Administration may direct as a means of enforcing such provisions including sanctions for non-compliance: Provided, however, that, in the event a contractor becomes involved in, or is threatened with, litigation with a subcontractor or supplier as a result of such direction, the contractor may request the State highway department to enter into such litigation to protect the interests of the State, and, in addition, the contractor may request the United States to enter into such litigation to protect the interests of the United States

## COUNTY MINORITY & FEMALE\* PERCENTAGES

1. Alcona_____5.2%	29. Gratiot_____5.2%	57. Missaukee____4.9%
2. Alger_____1.0%	30. Hillsdale_____5.5%	58. Monroe_____8.8%
3. Allegan_____4.9%	31. Houghton_____1.0%	59. Montcalm____4.9%
4. Alpena_____5.2%	32. Huron _____5.2%	60. Montmorency__5.2%
5. Antrim_____4.9%	33. Ingham_____5.5%	61. Muskegon_____9.7%
6. Arenac_____5.2%	34. Ionia_____5.5%	62. Newaygo_____4.9%
7. Baraga_____1.0%	35. Iosco_____5.2%	63. Oakland_____17.7%
8. Barry_____7.2%	36. Iron_____1.0%	64. Oceana_____9.7%
9. Bay_____2.2%	37. Isabella_____5.2%	65. Ogemaw_____5.2%
10. Benzie_____4.9%	38. Jackson_____5.1%	66. Ontonagon____1.2%
11. Berrien_____6.2%	39. Kalamazoo____5.9%	67. Osceola_____4.9%
12. Branch_____5.5%	40. Kalkaska_____4.9%	68. Oscoda_____5.2%
13. Calhoun_____7.2%	41. Kent_____5.2%	69. Otsego_____5.2%
14. Cass_____6.2%	42. Keweenaw____1.0%	70. Ottawa_____5.2%
15. Charlevoix___4.9%	43. Lake_____4.9%	71. Presque Isle__5.2%
16. Cheboygan___5.2%	44. Lapeer _____17.7%	72. Roscommon___5.2%
17. Chippewa___5.2%	45. Leelanau_____4.9%	73. Saginaw_____14.3%
18. Clare_____5.2%	46. Lenawee_____7.3%	74. Sanilac_____16.7%
19. Clinton_____5.5%	47. Livingston___17.5%	75. Schoolcraft___1.0%
20. Crawford____5.2%	48. Luce_____5.2%	76. Shiawassee__12.6%
21. Delta_____1.0%	49. Mackinac____5.2%	77. St. Clair_____17.7%
22. Dickinson___1.0%	50. Macomb_____17.7%	78. St. Joseph____5.2%
23. Eaton_____5.5%	51. Manistee_____4.9%	79. Tuscola_____5.2%
24. Emmet_____4.9%	52. Marquette____1.0%	80. VanBuren_____5.9%
25. Genesee___12.6%	53. Mason_____4.9%	81. Washtenaw___8.5%
26. Gladwin_____5.2%	54. Mecosta_____4.9%	82. Wayne _____17.7%
27. Gogebic_____1.2%	55. Menominee___1.0%	83. Wexford_____4.9%
28. Gr. Traverse__4.9%	56. Midland_____5.2%	

\*The construction goal for women in any Michigan county is 6.9%

Minority and female percentages are taken from the Office of Federal Contract Compliance Program Statistics.

**Notice of Requirement for Affirmative Action  
To Ensure Equal Employment Opportunity for Construction  
(EXECUTIVE ORDER 11246)**

1. The offeror's or bidder's attention is called to the Equal Opportunity clause and the Affirmative Action Compliance Requirements for Construction clause of this solicitation.
2. The goals for minority and female participation, expressed in percentage terms for the Contractor's aggregate workforce in each trade on all construction work in the covered area, are as follows:

Goals for Minority participation for each trade	Goals for Female participation for each trade
See County Minority and Female Percentages chart	6.9%

These goals are applicable to all Contractor's construction work performed in the covered area. If the Contractor performs construction work in a geographical area located outside of the covered area, the Contractor shall apply the goals established for the geographical area where the work is actually performed. With regard to this second area, the contractor also is subject to the goals for both its federally involved and non-federally involved construction.

The Contractor's compliance with Executive Order 11246, as amended, and the regulations in 41 CFR 60-4 shall be based on **(1)** its implementation of the Equal Opportunity clause, **(2)** specific affirmative action obligations required by the clause entitled *Affirmative Action Compliance Requirements for Construction*, and **(3)** its efforts to meet the goals. The hours of minority and female employment and training must be substantially uniform throughout the length of the contract, and in each trade. The Contractor shall make a good faith effort to employ minorities and women evenly on each of its projects. The transfer of minority or female employees or trainees from Contractor to Contractor or from project to project, for the sole purpose of meeting the Contractor's goals shall be a violation of the contract, Executive Order 11246, as amended, and the regulations in 41 CFR 60-4. Compliance with the goals will be measured against the total work hours performed.

3. The Contractor shall provide written notification to the Deputy Assistant Secretary for Federal Contract Compliance, U.S. Department of Labor, within 10 working days following award of any construction subcontract in excess of \$10,000 at any tier for construction work under the contract resulting from this solicitation. The notification shall list the—
  - Name, address, and telephone number of the subcontractor;
  - Employer's identification number of the subcontractor;
  - Estimated dollar amount of the subcontract;
  - Estimated starting and completion dates of the subcontract; and
  - Geographical area in which the subcontract is to be performed.
4. For this Notice, and in any contract resulting from this solicitation, the covered area is the county or counties listed in the Notice of Advertisement. When multiple counties are listed, the minority participation percentage is determined by the covered area county with the greater percentage.

[48 FR 42478, Sept. 19, 1983, as amended at 55 FR 38518, Sept. 18, 1990; 63 FR 70286, Dec. 18, 1998]



**STANDARD FEDERAL EQUAL EMPLOYMENT OPPORTUNITY  
CONSTRUCTION CONTRACT SPECIFICATIONS  
(EXECUTIVE ORDER 11246)**

1. **As used in these specifications:**
  - a. **“Covered area” means the geographical area described in the solicitation from which this contract resulted;**
  - b. **“Director” means Director, Office of Federal Contract Compliance Programs, United States Department of Labor, or any person to whom the Director delegates authority;**
  - c. **“Employer identification number” means the Federal Social Security number used on the Employer’s Quarterly Federal Tax Return, U.S. Treasury Department Form 941.**
  - d. **“Minority” includes:**
    - (i) **Black (all person having origins in any of the Black African racial groups not of Hispanic origin); and**
    - (ii) **Hispanic (all persons of Mexican, Puerto Rican, Cuban, Central or South American or other Spanish Culture of origin, regardless of race); and**
    - (iii) **Asian and Pacific Islander (all persons having origins in any of the original peoples of the Far East, South East Asia, the Indian Subcontinent, or the Pacific Islands); and**
    - (iv) **American Indian or Alaskan Native (all persons having origins in any of the original peoples of North America and maintaining identifiable tribal affiliations through membership and participation and participation or community identification).**
2. **Whenever the Contractor, or any Subcontractor at any tier, subcontracts a portion of the work involving any construction trade, it shall physically include in each subcontract in excess of \$10,000 the provisions of these specifications and the Notice which contains the applicable goals for minority and female participation and which is set forth in the solicitation from which this contract resulted.**
3. **If the Contractor is participating (pursuant to 41 CFR 60.4.5) in a Hometown Plan approved by the U.S. Department of Labor in the covered area either individually or through an association, its affirmative action obligations on all work in the Plan area (including goals and timetables) shall be in accordance with that Plan for those trades which have unions participating in the Plan. Contractors must be able to demonstrate their participation in and compliance with the provisions of any such**

**Hometown Plan. Each Contractor or Subcontractor participating in an approved Plan is individually required to comply with its obligations under the EEO clause, and to make good faith effort to achieve each goal under the Plan in each trade in which it has employees. The overall good faith performance by other Contractors or Subcontractors toward a goal in an approved Plan does not excuse any covered Contractor's or Subcontractor's failure to take good faith efforts to achieve the Plan goals and timetables.**

- 4. The Contractor shall implement the specific affirmative action standards provided in paragraph 7a through p of these specifications. The goals set forth in the solicitation from which this contract resulted are expressed as percentages of the total hours of employment and training of minority and female utilization the Contractor should reasonably be able to achieve in each construction trade in which it has employees in the covered area. Covered construction contractors performing construction work in geographical areas where they do not have a Federal or federally assisted construction contract shall apply the minority and female goals established for the geographical area where the work is being performed. Goals are published periodically in the Federal Register in notice form, and such notices may be obtained from any Office of Federal Contract Compliance Programs office or from Federal procurement contracting officers. The Contractor is expected to make substantially uniform progress in meeting its goals in each craft during the period specified.**
- 5. Neither the provisions of any collective bargaining agreement, nor the failure by a union with whom the Contractor has collective bargaining agreement, to refer either minorities or women shall excuse the Contractor's obligations under these specifications, Executive Order 11246, or the regulations promulgated pursuant thereto.**
- 6. In order for the nonworking training hours of apprentices and trainees to be counted in meeting the goals, such apprentices and trainees must be employed by the Contractor during the training period, and the Contractor must have made a commitment to employ the apprentices and trainees at the completion of their training, subject to the availability of employment opportunities. Trainees must be trained pursuant to training programs approved by the U.S. Department of Labor.**
- 7. The Contractor shall take specific affirmative actions to ensure equal employment opportunity. The evaluation of the Contractor's compliance with these specifications shall be based upon its effort to achieve maximum results from its actions. The Contractor shall document these efforts fully, and shall implement affirmative action steps at least as extensive as the following:**
  - a. Ensure and maintain a working environment free of harassment, intimidation, and coercion at all sites, and in all facilities at which the Contractor's employees are assigned to work. The Contractor, where possible, will assign two or more women to each construction project. The Contractor shall specifically ensure that all foremen, superintendents, and other on-site supervisory personnel are aware of and carry out the Contractor's obligation to maintain such a working environment, with specific attention to minority or female individuals working at such sites or in such facilities.**
  - b. Establish and maintain a current list of minority and female recruitment sources, provide written notification to minority and female recruitment sources and to community organizations when the Contractor or its unions have employment opportunities available, and maintain a record of the organizations' responses.**
  - c. Maintain a current file of the names, addresses and telephone numbers of each minority and female off-the-street applicant and minority or female referral from a**

union, a recruitment source or community organization and of what action was taken with respect to each such individual. If such individual was sent to the union hiring hall for referral and was not referred back to the Contractor by the union or, if referred, not employed by the Contractor, this shall be documented in the file with the reason therefor, along with whatever additional actions the Contractor may have taken.

- d. Provide immediate written notification to the Director when the union or unions with which the Contractor has a collective bargaining agreement has not referred to the Contractor a minority person or woman sent by the Contractor, or when the Contractor has other information that the union referral process has impeded the contractor's efforts to meet its obligations.
- e. Develop on-the-job training opportunities and/or participate in training programs for the area which expressly include upgrading programs and apprenticeship and trainee programs relevant to the contractor's employment needs, especially those programs funded or approved by the Department of Labor. The Contractor shall provide notice of these programs to the sources complied under 7b above.
- f. Disseminate the Contractor's EEO policy by providing notice of the policy to unions and training programs and requesting their cooperation in assisting the Contractor in meeting its EEO obligations; by including it in any policy review of the policy with all management personnel and with all minority and female employees at least once a year; and by posting the company EEO policy on bulletin boards accessible to all employees at each location where construction is performed.
- g. Review, at least annually, the company's EEO policy and affirmative action obligations under these specifications with all employees having any responsibility for hiring, assignment, layoff, termination or other employment decisions including specific review of these items with onsite supervisory personnel such as Superintendents, General Foremen, etc., prior to the initiation of construction work at any job site. A written record shall be made and maintained identifying the time and place of these meetings, persons attending, subject matter discussed, and disposition of the subject matter.
- h. Disseminate the Contractor's EEO policy externally by including it in any advertising in the news media, specifically including minority and female news media, and providing written notification to and discussing the Contractor's EEO policy with other Contractors and Subcontractors with whom the Contractor does or anticipates doing business.
- I. Direct its recruitment efforts, both oral and written, to minority, female and community organizations, to schools with minority and female students and to minority and female recruitment and training organizations serving the Contractor's recruitment area and employment needs. Not later than one month prior to the date for the acceptance of applications for apprenticeship or other training by any recruitment source, the Contractor shall send written notification to organizations such as the above, describing the openings, screening procedures, and tests to be used in the selection process.
- j. Encourage present minority and female employees to recruit other minority persons

and women and, where reasonable, provide after school, summer and vacation employment to minority and female youth both on the site and in other areas of a Contractor's workforce.

- k. **Validate all tests and other selection requirements where there is an obligation to do so under 41 CFR Part 60.3.**
  - l. **Conduct, at least annually, an inventory and evaluation at least of all minority and female personnel for promotional opportunities and encourage these employees to seek or to prepare for, through appropriate training, etc., such opportunities.**
  - m. **Ensure that seniority practices, job classifications, work assignments and other personnel practices, do not have a discriminatory effect by continually monitoring all personnel and employment related activities to ensure that the EEO policy and the Contractor's obligations under these specifications are being carried out.**
  - n. **Ensure that all facilities and company activities are nonsegregated except that separate or single-user toilet and necessary changing facilities shall be provided to assure privacy between the sexes.**
  - o. **Document and maintain a record of all solicitations of offers for subcontracts from minority and female construction contractors and suppliers, including circulation of solicitations to minority and female contractor associations and other business associations.**
  - p. **Conduct a review, at least annually, of all supervisors' adherence to and performance under the Contractor's EEO policies and affirmative action obligations.**
8. **Contractors are encouraged to participate in voluntary associations which assist in fulfilling one or more of their affirmative action obligations (7a through p). The efforts of a contractor association, joint contractor-union, contractor-community, or other similar group of which the contractor is a member and participant, may be asserted as fulfilling any one or more of its obligations under 7a through p of these Specifications provided that the contractor actively participates in the group, makes every effort to assure that the group has a positive impact on the employment of minorities and women in the industry, ensures that the concrete benefits of the program are reflected in the Contractor's minority and female workforce participation, makes a good faith effort to meet its individual goals and timetable, and can provide access to documentation which demonstrates the effectiveness of actions taken on behalf of the Contractor. The obligation to comply, however, is the Contractor's and failure of such a group to fulfill an obligation shall not be a defense for the Contractor's noncompliance.**
9. **A single goal for minorities and separate single goal for women have been established. The Contractor, however, is required to provide equal employment opportunity and to take affirmative action for all minority groups, both male and female, and all women, both minority and non-minority. Consequently, the Contractor may be in violation of the Executive Order if a particular group is employed in a substantially disparate manner (for example, even though the Contractor has achieved its goals for women generally, the Contractor may be in violation of the Executive Order if a specific minority group of women is underutilized).**
10. **The Contractor shall not use the goals and timetables or affirmative action standards to discriminate against any person because of race, color, religion, sex, or national origin.**

11. The Contractor shall not enter into any subcontract with any person or firm debarred from Government contracts pursuant to Executive Order 11246.
12. The Contractor shall carry out such sanctions and penalties for violation of these specifications and of the Equal Opportunity Clause, including suspension, termination and cancellation of existing subcontracts as may be imposed or ordered pursuant to Executive Order 11246, as amended, and its implementing regulations, by the Office of Federal Contract Compliance Programs. Any Contractor who fails to carry out such sanctions and penalties shall be in violation of these specifications and Executive Order 11246, as amended.
13. The Contractor, in fulfilling its obligations under these specifications, shall implement specific affirmative action steps, at least as extensive as those standards prescribed in paragraph 7 of these specifications, so as to achieve maximum results from its efforts to ensure equal employment opportunity. If the Contractor fails to comply with the requirements of the Executive Order, the implementing regulations, or these specifications, the Director shall proceed in accordance with 41 CFR 60-4.8.
14. The Contractor shall designate a responsible official to monitor all employment related activity to ensure that the company EEO policy is being carried out, to submit reports relating to the provisions hereof as may be required by the Government and to keep records. Records shall at least include for each employee the name, address, telephone numbers, construction trade, union affiliation if any, employee identification number when assigned, social security number, race, sex, status (e.g. mechanic, apprentice, trainee, helper, or laborer), dates of changes in status, hours worked per week in the indicated trade, rate of pay, and locations at which the work was performed. Records shall be maintained in an easily understandable and retrievable form; however, to the degree that existing records satisfy this requirement, contractors shall not be required to maintain separate records.
15. Nothing herein provided shall be construed as a limitation upon the application of other laws which establish different standards of compliance or upon the application of requirements for the hiring of local or other area residents (e.g. those under the Public Works Employment Act of 1977 and the Community Development Block Grant Program).

**Detroit Area Office**

Christopher Edwards, Area Office Director  
 U.S. DOL/ESA/OFCCP  
 Detroit Area Office  
 211 West Fort Street  
 Detroit, Michigan 48226  
 Phone: 313/226-3728

**Michigan Counties:**

Alcona	Benzie	Clare	Grand Traverse	Isabella	Lenawee
Allegan	Berrien	Clinton	Gratiot	Kalamazoo	Livingston
Alpena	Branch	Crawford	Hillsdale	Kalkaska	Macomb
Antrim	Calhoun	Eaton	Huron	Kent	Manistee
Arenac	Cass	Emmet	Ingham	Lake	Mason
Barry	Charlevoix	Genesee	Ionia	Lapeer	Mecosta
Bay	Cheboygan	Gladwin	Iosco	Leelanau	Midland

**Michigan Counties:**

<b>Missaukee</b>	<b>Oceana</b>	<b>Roscommon</b>	<b>Van Buren</b>
<b>Monroe</b>	<b>Ogemaw</b>	<b>St. Clair</b>	<b>Washtenaw</b>
<b>Montcalm</b>	<b>Osceola</b>	<b>St. Joseph</b>	<b>Wayne</b>
<b>Montmorency</b>	<b>Oscoda</b>	<b>Saginaw</b>	<b>Wexford</b>
<b>Muskegon</b>	<b>Otsego</b>	<b>Sanilac</b>	
<b>Newaygo</b>	<b>Ottawa</b>	<b>Shiawassee</b>	
<b>Oakland</b>	<b>Presque Isle</b>	<b>Tuscola</b>	

**Milwaukee Area Office**

**Mr. Robert Potter**  
**U.S. DOL/ESA/OFCCP**  
**Milwaukee Area Office**  
**Reuss Federal Bldg., Room 1115**  
**310 West Wisconsin**  
**Milwaukee, Wisconsin 53203**  
**Phone: 414/291-3822**

**Michigan Counties:**

<b>Alger</b>	<b>Delta</b>	<b>Houghton</b>	<b>Luce</b>	<b>Menominee</b>
<b>Baraga</b>	<b>Dickinson</b>	<b>Iron</b>	<b>Mackinac</b>	<b>Ontonagon</b>
<b>Chippewa</b>	<b>Gogebic</b>	<b>Keweenaw</b>	<b>Marquette</b>	<b>Schoolcraft</b>

## SPECIAL PROVISIONS

### 23 CFR CH.1 P 4.230, SUBPT..a, APP. A

#### Specific Equal Employment Opportunity Responsibilities

##### 1. General

- a. Equal employment opportunity requirements not to discriminate and to take affirmative action to assure equal employment opportunity as required by Executive Order 11246 and Executive Order 11375 are set forth in Required Contract Provisions (Form PR-1273 or 1316, as appropriate) and these Special Provisions that are imposed pursuant to Section 140 of Title 23, U.S.C. as established by Section 22 of the Federal Highway Act of 1968. The requirements set forth in these Special Provisions shall constitute the specific affirmative action requirements for project activities under this contract and supplement the equal employment opportunity requirements set forth in the Required Contract Provisions.
- b. The contractor will work with the State highway agencies and the Federal Government in carrying out equal employment opportunity obligations and in their review of his/her activities under the contract.
- c. The contractors and all his/her subcontractors holding subcontracts not including material suppliers, of \$10,000 or more, will comply with the following minimum specific requirement activities of equal employment opportunity: (The equal employment opportunity requirements of Executive Order 11246, as set forth in Volume 6, Chapter 4, Section 1, Subsection 1 of the Federal-Aid Highway Program Manual, are applicable to material suppliers as well as Contractors and Subcontractors.) The Contractor will include these requirements in every subcontract of \$10,000 or more with such modification of language as is necessary to make them binding on the Subcontractor.

##### 2. Equal Employment Opportunity Policy

The contractor will accept as operating policy the following statement which is designed to further the provision of equal employment opportunity to all persons without regard to their race, color, religion, sex, or national origin, and to promote the full realization of equal employment opportunity through a positive continuing program:

It is the policy of this Company to assure that applicants are employed and that employees are treated during employment, without regard to their race, religion, sex, color, or national origin. Such action shall include: employment, upgrading, demotion, or transfer; recruitment or recruitment advertising; layoff or termination; rates of pay or other forms of compensation; and selection for training, including apprenticeship, preapprenticeship, and/or on-the-job training.

##### 3. Equal Employment Opportunity Officer

The contractor will designate and make known to the State highway agency contracting officers an equal employment opportunity officer (hereinafter referred to as the EEO Officer) who will have the responsibility for and must be capable of effectively administering and promoting an active contractor program of equal employment opportunity and who must be assigned adequate authority and responsibility to do so.

##### 4. Dissemination of Policy

- a. All members of the contractor's staff who are authorized to hire, supervise, promote, and discharge employees, or who recommend such action, or who are substantially involved in such action, will be made fully cognizant of, and will implement, the contractor's equal employment opportunity policy and contractual responsibilities to provide equal employment opportunity in each grade and classification of employment. To ensure that the above agreement will be met, the following actions will be taken as a minimum:
  - (1) Periodic meetings of supervisory and personnel office employees will be conducted before the start of work and then not less often than once every six months, at which time the contractor's equal employment opportunity policy and its implementation will be reviewed and explained. The meetings will be conducted by the EEO Officer or other knowledgeable company official.
  - (2) All new supervisory or personnel office employees will be given a thorough indoctrination by the EEO Officer or other knowledgeable company official covering all major aspects of the contractor's equal employment opportunity obligations within thirty days following their reporting for duty with the contractor.
  - (3) All personnel who are engaged in direct recruitment for the project will be instructed by the EEO Officer or appropriate company official in the contractor's procedures for locating and hiring minority group employees.
- b. In order to make the contractor's equal employment opportunity policy known to all employees, prospective employees, and potential sources of employees, i.e., schools, employment agencies, labor unions (where appropriate), college placement officers, etc., the contractor will take the following actions:
  - (1) Notice and posters setting forth the contractor's equal employment opportunity policy will be placed in areas readily accessible to employees, applicants for employment, and potential employees.
  - (2) The contractor's equal employment opportunity policy and the procedures to implement such policy will be brought to the attention of employees by means of meetings, employee handbooks, or other appropriate means.

##### 5. Recruitment

- a. When advertising for employees, the contractor will include in all advertisements for employees the notation: "An Equal Opportunity Employer." All such advertisements will be published in newspapers or other publications having a large circulation among minority groups in the area from which the project work force would normally be derived.
- b. The contractor will, unless precluded by a valid bargaining agreement, conduct systematic and direct recruitment through public and private employee referral sources likely to yield qualified minority group applicants, including but not limited to, State employment agencies, schools, colleges, and minority group organizations. To meet this requirement, the contractor will, through his EEO Officer, identify sources of potential minority group employees, and establish with such identified sources of procedures whereby minority group applicants may be referred to the Contractor for employment consideration.

In the event the contractor has a valid bargaining agreement providing for exclusive hiring hall referrals, he is expected to observe the provisions of that agreement to the extent that the system permits the contractor's compliance with equal employment opportunity contract provisions. (The U.S. Department of Labor has held that where implementation of such agreements have the effect of discriminating against minorities or women, or obligates the contractor to do the same, such implementation violates Executive Order 11246, as amended.)

- c. The contractor will encourage his present employees to refer minority group applicants for employment by posting appropriate notices or bulletins in areas accessible to all such employees. In addition, information and procedures with regard to referring minority group applicants will be discussed with employees.

#### 6. Personnel Actions

Wages, working conditions, and employee benefits shall be established and administered, and personnel actions of every type, including hiring, upgrading, promotion, transfer, demotion, layoff, and termination, shall be taken without regard to race, color, religion, sex, or national origin. The following procedures shall be followed:

- a. The contractor will conduct periodic inspections of project sites to ensure that working conditions and employee facilities do not indicate discriminatory treatment of project site personnel.
- b. The contractor will periodically evaluate the spread of wages paid within each classification to determine any evidence of discriminatory wage practices.
- c. The contractor will periodically review selected personnel actions in depth to determine whether there is evidence of discrimination. Where evidence is found, the Contractor will promptly take corrective action. If the review indicates that the discrimination may extend beyond the actions reviewed, such corrective action shall include all affected persons.
- d. The contractor will promptly investigate all complaints of alleged discrimination made to the contractor in connection with his obligations under this contract, will attempt to resolve such complaints, and will take appropriate corrective action within a reasonable time. If the investigation indicates that the discrimination may affect persons other than the complainant, such corrective action shall include such other persons. Upon completion of each investigation, the contractor will inform every complainant of all avenues of appeal.

#### 7. Training and Promotion

- a. The contractor will assist in locating, qualifying, and increasing the skill of minority group and women employees, and applicants for employment.
- b. Consistent with the contractor's work force requirements and as permissible under Federal and State regulations, the Contractor shall make full use of training programs i.e., apprenticeship and on-the-job training programs for the geographical area of contract performance. Where feasible, 25 percent of apprentices or trainees in each occupation shall be in their first year of apprenticeship or training. In the event the Training Special Provision is provided under this contract, this subparagraph will be superseded as indicated in Attachment 2.
- c. The contractor will advise employees and applicants for employment of available training programs and entrance requirements for each.
- d. The contractor will periodically review the training and promotion potential of minority group and women employees and will encourage eligible employees to apply for such training and promotion.

#### 8. Unions

If the contractor relies in whole or in part upon unions as a source of employees, the contractor will use his/her best efforts to obtain the cooperation of such unions to increase opportunities for minority groups and women within the unions, and to effect referrals by such unions of minority and female employees. Actions by the contractor either directly or through a contractor's association acting as agent will include the procedures set forth below:

- a. The contractor will use best efforts to develop, in cooperation with the unions, joint training programs aimed toward qualifying more minority group members and women for membership in the unions and increasing the skills of minority group employees and women so that they may qualify for higher paying employment.
- b. The contractor will use their best efforts to incorporate an equal employment opportunity clause into each union agreement to the end that such union will be contractually bound to refer applicants without regard to their race, color, religion, sex, or national origin.
- c. The contractor is to obtain information as to the referral practices and policies of the labor union except that to the extent such



information is within the exclusive possession of the labor union and such labor union refuses to furnish such information to the contractor, the contractor shall so certify to the State highway department and shall set forth what efforts have been made to obtain such information.

- d. In the event the union is unable to provide the contractor with a reasonable flow of minority and women referrals within the time limit set forth in the collective bargaining agreement, the contractor will, through independent recruitment efforts, fill the employment vacancies without regard to race, color, religion, sex, or national origin, making full efforts to obtain qualified and/or qualifiable minority group persons and women. (The U.S. Department of Labor has held that it shall be no excuse that the union with which the contractor has a collective bargaining agreement providing for exclusive referral failed to refer minority employees.) In the event the union referral practice prevents the contractor from meeting the obligations pursuant to Executive Order 11246, as amended, and these special provisions, such contractor shall immediately notify the State highway agency.

9. Subcontracting

- a. The contractor will use his best efforts to solicit bids from and to utilize minority group subcontractors or subcontractors with meaningful minority group and female representation among their employees. Contractors shall obtain lists of minority-owned construction firms from State highway agency personnel.
- b. The contractor will use his best efforts to ensure subcontractor compliance with their equal employment opportunity obligations.

10. Records and Reports

- a. The contractor will keep such records as are necessary to determine compliance with the contractor's equal employment opportunity obligations. The records kept by the contractor will be designed to indicate:
  - (1) the number of minority and non-minority group members and women employed in each work classification on the project;
  - (2) the progress and efforts being made in cooperation with unions to increase employment opportunities for minorities and women (applicable only to contractors who rely in whole or in part on unions as a source of their work force),
  - (3) the progress and efforts being made in locating, hiring, training, qualifying, and upgrading minority and female employees, and the progress and efforts being made in securing the services of minority group subcontractors or subcontractors with meaningful minority and female representation among their employees.
- b. All such records must be retained for a period of three years following completion of the contract work and shall be available at reasonable times and places for inspection by authorized representatives of the State highway agency and the Federal Highway Administration.
- c. The contractor will submit to the State highway agency a monthly report for the first three months after construction begins and every month of July for the duration of the project, indicating the number of minority, women, and non-minority group employees currently engaged in each work classification required by the contract work. This information is to be reported on Form PR-1391. If on-the-job training is being required by "Training Special Provision," the contractor will be required to furnish Form FHWA 1409.

GENERAL DECISION NUMBER: MI140001 09/05/2014 MI1

Superseded General Decision Number: MI20130001

State: Michigan

Construction Types: Highway (Highway, Airport & Bridge xxxxx and Sewer/Incid. to Hwy.)

Counties: Michigan Statewide.

Modification Number	Publication Date
0	01/03/2014
1	01/24/2014
2	02/07/2014
3	02/14/2014
4	02/28/2014
5	03/21/2014
6	04/04/2014
7	04/11/2014
8	04/18/2014
9	05/09/2014
10	05/30/2014
11	06/06/2014
12	06/13/2014
13	06/20/2014
14	06/27/2014
15	07/04/2014
16	07/11/2014
17	07/18/2014
18	07/25/2014
19	08/01/2014
20	08/15/2014
21	09/05/2014

CARP0004-004 06/01/2013

REMAINDER OF STATE

	Rates	Fringes
CARPENTER ( Piledriver).....	\$ 25.34	17.37

CARP0004-005 06/01/2013

LIVINGSTON (Townships of Brighton, Deerfield, Genoa, Hartland, Oceola & Tyrone), MACOMB, MONROE, OAKLAND, SANILAC, ST. CLAIR AND WAYNE COUNTIES

	Rates	Fringes
CARPENTER (Piledriver).....	\$ 28.09	24.31

ELEC0017-005 06/02/2014

STATEWIDE

	Rates	Fringes
Line Construction		
Groundman/Driver.....	\$ 26.63	12.70
Journeyman Signal Tech, Communications Tech, Tower Tech & Fiber Optic Splicers.	\$ 36.16	15.37
Journeyman Specialist.....	\$ 41.58	16.89
Operator A.....	\$ 30.63	13.82
Operator B.....	\$ 28.62	13.26

Classifications

Journeyman Specialist: Refers to a crew of only one person working alone.

Operator A: Shall be proficient in operating all power equipment including: Backhoe, Excavator, Directional Bore and Boom/Digger truck.

Operator B: Shall be proficient in operating any 2 of the above mentioned pieces of equipment listed under Operator A.

-----  
 ENGI0324-003 06/01/2014

ALCONA, ALPENA, ARENAC, BAY, CHEBOYGAN, CLARE, CLINTON, CRAWFORD, GENESEE, GLADWIN, GRATIOT, HURON, INGHAM, IOSCO, ISABELLA, JACKSON, LAPEER, LENAWEE, LIVINGSTON, MACOMB, MIDLAND, MONROE, MONTMORENCY, OAKLAND, OGEMAW, OSCODA, OTSEGO, PRESQUE ISLE, ROSCOMMON, SAGINAW, ST. CLAIR, SANILAC, SHIAWASSEE, TUSCOLA, WASHTENAW AND WAYNE COUNTIES:

	Rates	Fringes
OPERATOR: Power Equipment		
(Steel Erection)		
GROUP 1.....	\$ 43.57	21.55
GROUP 2.....	\$ 44.57	21.55
GROUP 3.....	\$ 42.07	21.55
GROUP 4.....	\$ 43.07	21.55
GROUP 5.....	\$ 40.57	21.55
GROUP 6.....	\$ 41.57	21.55
GROUP 7.....	\$ 40.30	21.55
GROUP 8.....	\$ 41.30	21.55
GROUP 9.....	\$ 39.85	21.55
GROUP 10.....	\$ 40.85	21.55
GROUP 11.....	\$ 39.12	21.55
GROUP 12.....	\$ 40.12	21.55
GROUP 13.....	\$ 38.76	21.55
GROUP 14.....	\$ 39.76	21.55
GROUP 15.....	\$ 38.12	21.55
GROUP 16.....	\$ 36.42	21.55
GROUP 17.....	\$ 31.31	21.55
GROUP 18.....	\$ 29.90	21.55

FOOTNOTE:

Paid Holidays: New Year's Day, Memorial Day, Fourth of July, Labor Day, Thanksgiving Day and Christmas Day.

POWER EQUIPMENT OPERATOR CLASSIFICATIONS

GROUP 1: Engineer when operating combination of boom and jib 400' or longer

GROUP 2: Engineer when operating combination of boom and jib 400' or longer on a crane that requires an oiler

GROUP 3: Engineer when operating combination of boom and jib 300' or longer

GROUP 4: Engineer when operating combination of boom and jib 300' or longer on a crane that requires an oiler

GROUP 5: Engineer when operating combination of boom and jib  
220' or longer

GROUP 6: Engineer when operating combination of boom and jib  
220' or longer on a crane that requires an oiler

GROUP 7: Engineer when operating combination of boom and jib  
140' or longer

GROUP 8: Engineer when operating combination of boom and jib  
140' or longer on a crane that requires an oiler

GROUP 9: Tower crane & derrick operator (where operator's  
work station is 50 ft. or more above first sub-level)

GROUP 10: Tower crane & derrick operator (where operator's  
work station is 50 ft. or more above first sub-level) on a  
crane that requires an oiler

GROUP 11: Engineer when operating combination of boom and jib  
120' or longer

GROUP 12: Engineer when operating combination of boom and jib  
120' or longer on a crane that requires an oiler

GROUP 13: Crane operator; job mechanic and 3 drum hoist and  
excavator

GROUP 14: Crane operator on a crane that requires an oiler

GROUP 15: Hoisting operator; 2 drum hoist and rubber tired  
backhoe

GROUP 16: Forklift and 1 drum hoist

GROUP 17: Compressor or welder operator

GROUP 18: Oiler

-----  
ENGI0324-004 06/01/2014

AREA 1: ALLEGAN, BARRY, BERRIEN, BRANCH, CALHOUN, CASS, EATON,  
HILLSDALE, IONIA, KALAMAZOO, KENT, LAKE, MANISTEE, MASON,  
MECOSTA, MONTCALM, MUSKEGON, NEWAYGO, OCEANA, OSCEOLA, OTTAWA,  
ST. JOSEPH, VAN BUREN

AREA 2: ANTRIM, BENZIE, CHARLEVOIX, EMMET, GRAND TRAVERSE,  
KALKASKA, LEELANAU, MISSAUKEE AND WEXFORD COUNTIES:

	Rates	Fringes
OPERATOR: Power Equipment (Steel Erection)		
AREA 1		
GROUP 1.....	\$ 29.44	21.70
GROUP 2.....	\$ 29.19	21.70
GROUP 3.....	\$ 28.69	21.70
GROUP 4.....	\$ 23.59	21.70
GROUP 5.....	\$ 21.94	21.70
GROUP 6.....	\$ 19.34	21.70
AREA 2		
GROUP 1.....	\$ 29.44	21.70
GROUP 2.....	\$ 29.19	21.70

GROUP 3.....	\$ 28.19	21.70
GROUP 4.....	\$ 23.29	21.70
GROUP 5.....	\$ 21.64	21.70
GROUP 6.....	\$ 18.84	21.70

FOOTNOTES:

Crane operator with main boom and jib 300' or longer: \$1.50 additional to the group 1 rate. Crane operator with main boom and jib 400' or longer: \$3.00 additional to the group 1 rate.

PAID HOLIDAYS: New Year's Day, Memorial Day, Fourth of July, Labor Day, Thanksgiving Day and Christmas Day.

POWER EQUIPMENT OPERATOR CLASSIFICATIONS:

GROUP 1: Crane Operator with main boom & jib 400', 300', or 220' or longer.

GROUP 2: Crane Operator with main boom & jib 140' or longer, Tower Crane; Gantry Crane; Whirley Derrick.

GROUP 3: Regular Equipment Operator, Crane, Dozer, Loader, Hoist, Straddle Wagon, Mechanic, Grader and Hydro Excavator.

GROUP 4: Air Tugger (single drum), Material Hoist Pump 6" or over, Elevators, Brokk Concrete Breaker.

GROUP 5: Air Compressor, Welder, Generators, Conveyors

GROUP 6: Oiler and fire tender

-----  
 ENGI0324-005 09/01/2013

AREA 1: GENESEE, LAPEER, LIVINGSTON, MACOMB, MONROE, OAKLAND, ST. CLAIR, WASHTENAW AND WAYNE COUNTIES

AREA 2: ALCONA, ALLEGAN, ALPENA, ANTRIM, ARENAC, BARRY, BAY, BENZIE, BERRIEN, BRANCH, CALHOUN, CASS, CHARLEVOIX, CHEBOYGAN, CLARE, CLINTON, CRAWFORD, EATON, EMMET, GLADWIN, GRAND TRAVERSE, GRATIOT, HILLSDALE, HURON, INGHAM, IONIA, IOSCO, ISABELLA, JACKSON, KALAMAZOO, KALKASKA, KENT, LAKE, LEELANAU, LENAWEE, MANISTEE, MASON, MECOSTA, MIDLAND, MISSAUKEE, MONTCALM, MONTMORENCY, MUSKEGON, NEWAYGO, OCEANA, OGEMAW, OSCEOLA, OSCODA, OTSEGO, OTTAWA, PRESQUE ISLE, ROSCOMMON, SAGINAW, SANILAC, SHIAWASSEE, ST. JOSEPH, TUSCOLA, VAN BUREN AND WEXFORD COUNTIES

	Rates	Fringes
OPERATOR: Power Equipment		
(Underground construction		
(including sewer))		
AREA 1:		
GROUP 1.....	\$ 29.98	20.25
GROUP 2.....	\$ 25.25	20.25
GROUP 3.....	\$ 24.52	20.25
GROUP 4.....	\$ 23.95	20.25
AREA 2:		
GROUP 1.....	\$ 28.27	20.25
GROUP 2.....	\$ 23.38	20.25
GROUP 3.....	\$ 22.88	20.25
GROUP 4.....	\$ 22.60	20.25

## POWER EQUIPMENT OPERATOR CLASSIFICATIONS

GROUP 1: Backfiller tamper; Backhoe; Batch plant operator (concrete); Clamshell; Concrete paver (2 drums or larger); Conveyor loader (Euclid type); Crane (crawler, truck type or pile driving); Dozer; Dragline; Elevating grader; Endloader; Gradall (and similar type machine); Grader; Mechanic; Power shovel; Roller (asphalt); Scraper (self-propelled or tractor drawn); Side boom tractor (type D-4 or equivalent and larger); Slip form paver; Slope paver; Trencher (over 8 ft. digging capacity); Well drilling rig; Concrete pump with boom operator; Hydro Excavator

GROUP 2: Boom truck (power swing type boom); Crusher; Hoist; Pump (1 or more - 6-in. discharge or larger - gas or diesel- powered or powered by generator of 300 amperes or more - inclusive of generator); Side boom tractor (smaller than type D-4 or equivalent); Tractor (pneu-tired, other than backhoe or front end loader); Trencher (8-ft. digging capacity and smaller); Vac Truck

GROUP 3: Air compressors (600 cfm or larger); Air compressors (2 or more-less than 600 cfm); Boom truck (non-swinging, non- powered type boom); Concrete breaker (self-propelled or truck mounted - includes compressor); Concrete paver (1 drum-1/2 yd. or larger); Elevator (other than passenger); Maintenance person; Pump (2 or more-4-in. up to 6-in. discharge-gas or diesel powered - excluding submersible pumps); Pumpcrete machine (and similar equipment); Wagon drill (multiple); Welding machine or generator (2 or more-300 amp. or larger - gas or diesel powered)

GROUP 4: Boiler; Concrete saw (40 hp or over); Curing machine (self-propelled); Farm tractor (with attachment); Finishing machine (concrete); Fire person; Hydraulic pipe pushing machine; Mulching equipment; Oiler; Pumps (2 or more up to 4-in. discharge, if used 3 hours or more a day, gas or diesel powered - excluding submersible pumps); Roller (other than asphalt); Stump remover; Trencher (service); Vibrating compaction equipment, self-propelled (6 ft. wide or over); End dump operator; Sweeper (Wayne type); Water wagon and Extend-a boom forklift

---

ENGI0324-006 06/01/2014

AREA 1: GENESEE, MACOMB, MONROE, OAKLAND, WASHTENAW AND WAYNE COUNTIES

AREA 2: ALCONA, ALGER, ALLEGAN, ALPENA, ANTRIM, ARENAC, BARAGA, BARRY, BAY, BENZIE, BERRIEN, BRANCH, CALHOUN, CASS, CHARLEVOIX, CHEBOYGAN, CHIPPEWA, CLARE, CLINTON, CRAWFORD, DELTA, DICKINSON, EATON, EMMET, GLADWIN, GOGEBIC, GRAND TRAVERSE, GRATIOT, HILLSDALE, HOUGHTON, HURON, INGHAM, IONIA, IOSCO, IRON, ISABELLA, JACKSON, KALAMAZOO, KALKASKA, KENT, KEWEENAW, LAKE, LAPEER, LEELANAU, LENAWEE, LIVINGSTON, LUCE, MACKINAC, MANISTEE, MARQUETTE, MASON, MECOSTA, MENOMINEE, MIDLAND, MISSAUKEE, MONTCALM, MONTMORENCY, MUSKEGON, NEWAYGO, OCEANA, OGEMAW, ONTONAGON, OSCEOLA, OSCODA, OTSEGO, OTTAWA, PRESQUE ISLE, ROSCOMMON, SAGINAW, ST. CLARE, ST. JOSEPH, SANILAC, SCHOOLCRAFT, SHIAWASSEE, TUSCOLA, VAN BUREN AND WEXFORD COUNTIES

Rates                      Fringes

Power equipment operators:  
(AIRPORT, BRIDGE & HIGHWAY  
CONSTRUCTION)

AREA 1		
GROUP 1.....	\$ 30.26	21.85
GROUP 2.....	\$ 23.53	21.85
GROUP 3.....	\$ 24.83	21.85
GROUP 4.....	\$ 22.97	21.85
GROUP 5.....	\$ 22.80	21.85
AREA 2		
GROUP 1.....	\$ 30.26	21.85
GROUP 2.....	\$ 23.38	21.85
GROUP 3.....	\$ 24.68	21.85
GROUP 4.....	\$ 22.82	21.85
GROUP 5.....	\$ 22.50	21.85

POWER EQUIPMENT OPERATOR CLASSIFICATIONS

GROUP 1: Asphalt plant operator; Crane operator (does not include work on bridge construction projects when the crane operator is erecting structural components); Dragline operator; Shovel operator; Locomotive operator; Paver operator (5 bags or more); Elevating grader operator; Pile driving operator; Roller operator (asphalt); Blade grader operator; Trenching machine operator (ladder or wheel type); Auto-grader; Slip form paver; Self-propelled or tractor-drawn scraper; Conveyor loader operator (Euclid type); Endloader operator (1 yd. capacity and over); Bulldozer; Hoisting engineer; Tractor operator; Finishing machine operator (asphalt); Mechanic; Pump operator (6-in. discharge or over, gas, diesel powered or generator of 300 amp. or larger); Shouldering or gravel distributing machine operator (self-propelled); Backhoe (with over 3/8 yd. bucket); Side boom tractor (type D-4 or equivalent or larger); Tube finisher (slip form paving); Gradall (and similar type machine); Asphalt paver (self-propelled); Asphalt planer (self-propelled); Batch plant (concrete-central mix); Slurry machine (asphalt); Concrete pump (3 in. and over); Roto-mill; Swinging boom truck (over 12 ton capacity); Hydro demolisher (water blaster); Farm-type tractor with attached pan

GROUP 2: Screening plant operator; Washing plant operator; Crusher operator; Backhoe (with 3/8 yd. bucket or less); Side boom tractor (smaller than D-4 type or equivalent); Sweeper (Wayne type and similar equipment); Vacuum truck operator; Batch plant (concrete dry batch)

GROUP 3: Grease Truck

GROUP 4: Air compressor operator (600 cu. ft. per min or more); Air compressor operator (two or more, less than 600 cfm); Wagon drill operator; Concrete breaker; Tractor operator (farm type with attachment)

GROUP 5: Boiler fire tender; Oiler; Fire tender; Trencher (service); Flexplane operator; Cleftplane operator; Grader operator (self-propelled fine-grade or form (concrete)); Finishing machine operator (concrete); Boom or winch hoist truck operator; Endloader operator (under 1 yd. capacity); Roller operator (other than asphalt); Curing equipment

operator (self-propelled); Concrete saw operator (40 h.p. or over); Power bin operator; Plant drier operator (asphalt); Vibratory compaction equipment operator (6 ft. wide or over); Guard post driver operator (power driven); All mulching equipment; Stump remover; Concrete pump (under 3-in.); Mesh installer (self-propelled); Tractor operator (farm type); End dump; Skid steer

-----  
 ENGI0324-007 07/01/2014

ALGER, BARAGA, CHIPPEWA, DELTA, DICKINSON, GOGEBIC, HOUGHTON, IRON, KEWEENAW, LUCE, MACKINAC MARQUETTE, MENOMINEE, ONTONAGON AND SCHOOLCRAFT COUNTIES:

	Rates	Fringes
OPERATOR: Power Equipment		
(Steel Erection)		
Compressor, welder and forklift.....	\$ 24.61	21.55
Crane operator, main boom & jib 120' or longer.....	\$ 28.36	21.55
Crane operator, main boom & jib 140' or longer.....	\$ 28.61	21.55
Crane operator, main boom & jib 220' or longer.....	\$ 28.86	21.55
Mechanic with truck and tools.....	\$ 29.36	21.55
Oiler and fireman.....	\$ 23.31	21.55
Regular operator.....	\$ 27.86	21.55

-----  
 ENGI0324-008 11/01/2013

ALCONA, ALGER, ALLEGAN, ALPENA, ANTRIM, ARENAC, BARAGA, BARRY, BAY, BENZIE, BERRIEN, BRANCH, CALHOUN, CASS, CHARLEVOIX, CHEBOYGAN, CHIPPEWA, CLARE, CLINTON, CRAWFORD, DELTA, DICKINSON, EATON, EMMET, GENESEE, GLADWIN, GOGEBIC, GRAND TRAVERSE, GRATIOT, HILLSDALE, HOUGHTON, HURON, INGHAM, IONIA, IOSCO, IRON, ISABELLA, JACKSON, KALAMAZOO, KALKASKA, KENT, KEWEENAW, LAKE, LAPEER, LEELANAU, LENAWEE, LIVINGSTON, LUCE, MACKINAC, MACOMB, MANISTEE, MARQUETTE, MASON, MECOSTA, MENOMINEE, MIDLAND, MISSAUKEE, MONTCALM, MONTMORENCY, MONROE, MUSKEGON, NEWAYGO, OAKLAND, OCEANA, OGEMAW, ONTONAGON, OSCEOLA, OSCODA, OTSEGO, OTTAWA, PRESQUE ISLE, ROSCOMMON, SAGINAW, ST. CLARE, ST. JOSEPH, SANILAC, SCHOOLCRAFT, SHIAWASSEE, TUSCOLA, VAN BUREN, WASHTENAW, WAYNE AND WEXFORD COUNTIES

	Rates	Fringes
OPERATOR: Power Equipment		
(Sewer Relining)		
GROUP 1.....	\$ 29.65	12.58
GROUP 2.....	\$ 28.12	12.58

SEWER RELINING CLASSIFICATIONS

GROUP 1: Operation of audio-visual closed circuit TV system, including remote in-ground cutter and other equipment used in connection with the CCTV system

GROUP 2: Operation of hot water heaters and circulation systems, water jettors and vacuum and mechanical debris removal systems



ALGER, BARAGA, CHIPPEWA, DELTA, DICKINSON, GOGEBIC, HOUGHTON,  
IRON, KEWEENAW, LUCE, MACKINAC, MARQUETTE, MENOMINEE, ONTONAGON  
AND SCHOOLCRAFT COUNTIES:

	Rates	Fringes
OPERATOR: Power Equipment (Underground Construction)		
Crane operator, main boom & jib 120' or longer.....	\$ 27.38	19.95
Crane operator, main boom & jib 140' or longer.....	\$ 27.63	19.95
Crane operator, main boom & jib 220' or longer.....	\$ 27.88	19.95
GROUP 1.....	\$ 26.88	19.95
GROUP 2.....	\$ 23.63	19.95
GROUP 3.....	\$ 23.05	19.95
GROUP 4.....	\$ 22.11	19.95
Mechanic with truck and tools.....	\$ 28.38	19.95

FOOTNOTES: Swing boom truck operator over 15 tons: \$.50 per hour additional. Hydraulic crane operator 75 tons and under: \$.75 per hour additional. Hydraulic crane operator over 75 tons: \$1.00 per hour additional. Lattice boom crane operator: \$1.50 per hour additional. Crusher pit, shafts and tunnel workers: \$2.00 per hour additional.

POWER EQUIPMENT OPERATOR CLASSIFICATIONS

GROUP 1: Regular equipment operator, crane, dozer, front end loader, job mechanic, pumpcrete and squeezeconcrete, concrete pump, excavator, milling and pulverizing machines, scraper (self-propelled and tractor drawn), welder

GROUP 2: Air track drill, boom truck (non-swing), concrete mixer, material hoist and tugger, pump 6" and over, beltcrete, sweeping machine, trencher, winches, well points and freeze systems

GROUP 3: Air compressor, conveyor, concrete saw, farm tractor (without attachments), fork truck, generator, guard post driver, mulching machine, pumps under 6-in., welding machine and grease person

GROUP 4: Oiler, fire tender, heater operator, brock concrete breaker, elevators (other than passenger), end dumps and skid steer

Crane Operator with main boom and jib 300' or longer shall be paid an additional one dollar and fifty cents (\$1.50) per hour above the 220' of boom and jib wage rate.

Crane Operator with main boom and jib 400' or longer shall be paid an additional one dollar and fifty cents (\$1.50) per hour above the 300 foot of boom wage rate (\$3.00)

AREA 1: GENESEE, LAPEER, LIVINGSTON, MACOMB, MONROE, OAKLAND, ST. CLAIR, WASHTENAW AND WAYNE COUNTIES

AREA 2: ALCONA, ALGER, ALLEGAN, ALPENA, ANTRIM, ARENAC, BARAGA, BARRY, BAY, BENZIE, BERRIEN, BRANCH, CALHOUN, CASS, CHARLEVOIX, CHEBOYGAN, CHIPPEWA, CLARE, CLINTON, CRAWFORD, DELTA, DICKINSON, EATON, EMMET, GLADWIN, GOGEBIC, GRAND TRAVERSE, GRATIOT, HILLSDALE, HOUGHTON, HURON, INGHAM, IONIA, IOSCO, IRON, ISABELLA, JACKSON, KALAMAZOO, KALKASKA, KENT, KEWEENAW, LAKE, LEELANAU, LENAWEE, LUCE, MACKINAC, MANISTEE, MARQUETTE, MASON, MECOSTA, MENOMINEE, MIDLAND, MISSAUKEE, MONTCALM, MONTMORENCY, MUSKEGON, NEWAYGO, OCEANA, OGEMAW, ONTONAGON, OSCEOLA, OSCODA, OTSEGO, OTTAWA, PRESQUE ISLE, ROSCOMMON, SAGINAW, ST. JOSEPH, SANILAC, SCHOOLCRAFT, SHIAWASSEE, TUSCOLA, VAN BUREN AND WEXFORD COUNTIES

	Rates	Fringes
Power equipment operators - hazardous waste removal: (AREA 1)		
AREA 1: LEVEL A		
Engineer when operating crane with boom and jib or leads 140' or longer....	\$ 34.68	19.70
Engineer when operating crane with boom and jib or leads 220' or longer....	\$ 34.98	19.70
GROUP 1.....	\$ 32.03	19.70
GROUP 2.....	\$ 27.80	19.70
Regular crane operator, mechanic, dragline operator, boom truck operator and concrete pump with boom operator, power shovel operator.....	\$ 33.00	19.70
AREA 1: LEVEL B AND C		
Engineer when operating crane with boom and jib or leads 140' or longer....	\$ 33.73	19.70
Engineer when operating crane with boom and jib or leads 220' or longer....	\$ 34.03	19.70
GROUP 1.....	\$ 31.08	19.70
GROUP 2.....	\$ 26.85	19.70
Regular crane operator, mechanic, dragline operator, boom truck operator and concrete pump with boom operator, power shovel operator.....	\$ 32.05	19.70
AREA 1: LEVEL D WHEN CAPPING LANDFILL		
Engineer when operating crane with boom and jib or leads 140' or longer....	\$ 32.18	19.70
Engineer when operating crane with boom and jib or leads 220' or longer....	\$ 32.48	19.70
GROUP 1.....	\$ 29.53	19.70
GROUP 2.....	\$ 25.30	19.70
Regular crane operator,		

mechanic, dragline operator, boom truck operator and concrete pump with boom operator, power shovel operator.....\$ 29.88	19.70
AREA 1: LEVEL D	
Engineer when operating crane with boom and jib or leads 140' or longer....\$ 32.43	19.70
Engineer when operating crane with boom and jib or leads 220' or longer....\$ 32.73	19.70
GROUP 1.....\$ 29.78	19.70
GROUP 2.....\$ 25.55	19.70
Regular crane operator, mechanic, dragline operator, boom truck operator and concrete pump with boom operator, power shovel operator.....\$ 30.75	19.70
Power equipment operators - hazardous waste removal: (AREA 2)	
AREA 2: LEVEL A	
Engineer when operating crane with boom and jib or leads 140' or longer....\$ 32.97	19.70
Engineer when operating crane with boom and jib or leads 220' or longer....\$ 33.27	19.70
GROUP 1.....\$ 30.32	19.70
GROUP 2.....\$ 25.92	19.70
Regular crane operator, mechanic, dragline operator, boom truck operator and concrete pump with boom operator, power shovel operator.....\$ 31.29	19.70
AREA 2: LEVEL B AND C	
Engineer when operating crane with boom and jib or leads 140' or longer....\$ 31.91	19.70
Engineer when operating crane with boom and jib or leads 220' or longer....\$ 32.23	19.70
GROUP 1.....\$ 29.37	19.70
GROUP 2.....\$ 24.98	19.70
Regular crane operator, mechanic, dragline operator, boom truck operator and concrete pump with boom operator, power shovel operator.....\$ 30.34	19.70
AREA 2: LEVEL D WHEN CAPPING LANDFILL	
Engineer when operating crane with boom and jib or leads 140' or longer....\$ 30.47	19.70
Engineer when operating crane with boom and jib or leads 220' or longer....\$ 30.77	19.70
GROUP 1.....\$ 27.82	19.70
GROUP 2.....\$ 23.43	19.70

Regular crane operator, mechanic, dragline operator, boom truck operator and concrete pump with boom operator, power shovel operator.....\$ 28.79	19.70
AREA 2: LEVEL D	
Engineer when operating crane with boom and jib or leads 140' or longer....\$ 30.72	19.70
Engineer when operating crane with boom and jib or leads 220' or longer....\$ 31.02	19.70
GROUP 1.....\$ 28.07	19.70
GROUP 2.....\$ 23.68	19.70
Regular crane operator, mechanic, dragline operator, boom truck operator and concrete pump with boom operator, power shovel operator.....\$ 29.04	19.70

HAZARDOUS WASTE REMOVAL CLASSIFICATIONS

Group 1: Backhoe, batch plant operator, clamshell, concrete breaker when attached to hoe, concrete cleaning decontamination machine operator, concrete pump, concrete paver, crusher, dozer, elevating grader, endloader, farm tractor (90 h.p. and higher), gradall, grader, heavy equipment robotics operator, loader, pug mill, pumpcrete machines, pump trucks, roller, scraper (self-propelled or tractor drawn), side boom tractor, slip form paver, slope paver, trencher, ultra high pressure waterjet cutting tool system, vactors, vacuum blasting machine operator, vertical lifting hoist, vibrating compaction equipment (self-propelled), well drilling rig and hydro excavator

GROUP 2: Air compressor, concrete breaker when not attached to hoe, elevator, end dumps, equipment decontamination operator, farm tractor (less than 90 h.p.), forklift, generator, heater, mulcher, pigs (portable reagent storage tanks), power screens, pumps (water), stationary compressed air plant, sweeper, welding machine and water wagon

-----  
ENGI0325-012 05/01/2014

AREA 1: MACOMB, MONROE, OAKLAND, ST. CLAIR, WASHTENAW AND WAYNE COUNTIES

AREA 2: ALCONA, ALGER, ALLEGAN, ALPENA, ANTRIM, ARENAC, BARAGA, BARRY, BAY, BENZIE, BERRIEN, BRANCH, CALHOUN, CASS, CHARLEVOIX, CHEBOYGAN, CHIPPEWA, CLARE, CLINTON, CRAWFORD, DELTA, DICKINSON, EATON, EMMET, GENESEE, GLADWIN, GOGEBIC, GRAND TRAVERSE, GRATIOT, HILLSDALE, HOUGHTON, HURON, INGHAM, IONIA, IOSCO, IRON, ISABELLA, JACKSON, KALAMAZOO, KALKASKA, KENT, KEWEENAW, LAKE, LAPEER, LEELANAU, LENAWEE, LIVINGSTON LUCE, MACKINAC, MANISTEE, MARQUETTE, MASON, MECOSTA, MENOMINEE, MIDLAND, MISSAUKEE, MONTCALM, MONTMORENCY, MUSKEGON, NEWAYGO, OCEANA, OGEMAW, ONTONAGON, OSCEOLA, OSCODA, OTSEGO, OTTAWA, PRESQUE ISLE, ROSCOMMON, SAGINAW, ST. JOSEPH, SANILAC, SCHOOLCRAFT, SHIAWASSEE, TUSCOLA, VAN BUREN AND WEXFORD COUNTIES

	Rates	Fringes
Power equipment operators - gas distribution and duct installation work:		
AREA 1		
GROUP 1.....	\$ 27.83	21.80
GROUP 2.....	\$ 27.70	21.80
GROUP 3.....	\$ 26.58	21.80
GROUP 4.....	\$ 26.00	21.80
AREA 2		
GROUP 1.....	\$ 26.92	21.80
GROUP 2-A.....	\$ 26.82	21.80
GROUP 2-B.....	\$ 26.60	21.80
GROUP 3.....	\$ 25.82	21.80
GROUP 4.....	\$ 25.32	21.80

SCOPE OF WORK: The construction, installation, treating and reconditioning of pipelines transporting gas vapors within cities, towns, subdivisions, suburban areas, or within private property boundaries, up to and including private meter settings of private industrial, governmental or other premises, more commonly referred to as "distribution work," starting from the first metering station, connection, similar or related facility, of the main or cross country pipeline and including duct installation.

AREA 1:

GROUP 1: Backhoe, crane, grader, mechanic, dozer (D-6 equivalent or larger), side boom (D-4 equivalent or larger), trencher(except service), endloader (2 yd. capacity or greater).

GROUP 2: Dozer (less than D-6 equivalent), endloader (under 2 yd. capacity), side boom (under D-4 capacity), backfiller, pumps (1 or 2 of 6-inch discharge or greater), boom truck (with powered boom), tractor (wheel type other than backhoe or front endloader).

GROUP 3: Tamper (self-propelled), boom truck (with non-powered boom), concrete saw (20 hp or larger), pumps (2 to 4 under 6-inch discharge), compressor (2 or more or when one is used continuously into the second day) and trencher(service).

GROUP 4: Oiler, hydraulic pipe pushing machine, grease person and hydrostatic testing operator.

AREA 2:

GROUP 1: Mechanic, crane (over 1/2 yd. capacity), backhoe (over 1/2 yd. capacity), grader (Caterpillar 12 equivalent or larger)

GROUP 2-A: Trencher(except service), backhoe (1/2 yd. capacity or less)

GROUP 2-B: Crane (1/2 yd. capacity or less), compressor (2 or more), dozer (D-4 equivalent or larger), endloader (1 yd. capacity or larger), pump (1 or 2 six-inch or larger), side boom (D-4 equivalent or larger)

GROUP 3: Backfiller, boom truck (powered), concrete saw (20 hp or larger), dozer (less than D-4 equivalent), endloader

(under 1 yd. capacity), farm tractor (with attachments),  
 pump (2 - 4 under six-inch capacity), side boom  
 tractor (less than D-4 equivalent), tamper (self-propelled),  
 trencher service and grader maintenance

GROUP 4: Oiler, grease person and hydrostatic testing operator

-----  
 IRON0008-007 06/01/2013

ALGER, BARAGA, CHIPPEWA, DELTA, DICKINSON, GOGEBIC, HOUGHTON,  
 IRON, KEWEENAW, LUCE, MACKINAC MARQUETTE, MENOMINEE, ONTONAGON  
 AND SCHOOLCRAFT COUNTIES:

	Rates	Fringes
Ironworker - pre-engineered metal building erector.....	\$ 23.70	6.95
IRONWORKER		
General contracts		
\$10,000,000 or greater.....	\$ 25.75	23.17
General contracts less than \$10,000,000.....	\$ 22.53	23.17

Paid Holidays: New Year's Day, Memorial Day, July 4th, Labor  
 Day, Thanksgiving Day & Christmas Day.

-----  
 IRON0025-002 06/01/2014

ALCONA, ALPENA, ARENAC, BAY, CHEBOYGAN, CLARE, CLINTON,  
 CRAWFORD, GENESEE, GLADWIN, GRATIOT, HURON, INGHAM, IOSCO,  
 ISABELLA, JACKSON, LAPEER, LIVINGSTON, MACOMB, MIDLAND,  
 MONTMORENCY, OAKLAND, OGEMAW, OSCODA, OTSEGO, PRESQUE ISLE,  
 ROSCOMMON, SAGINAW, SANILAC, SHIAWASSEE, ST. CLAIR, TUSCOLA,  
 WASHTENAW AND WAYNE COUNTIES:

	Rates	Fringes
Ironworker - pre-engineered metal building erector		
Alcona, Alpena, Arenac, Cheboygan, Clare, Clinton, Crawford, Gladwin, Gratiot, Huron, Ingham, Iosco, Isabella, Jackson, Lapeer, Livingston (west of Burkhardt Road), Montmorency, Ogemaw, Oscoda, Otsego, Presque Isle, Roscommon, Sanilac, Shiawassee, Tuscola & Washtenaw (west of U.S. 23).....	\$ 22.17	20.13
Bay, Genesee, Lapeer, Livingston (east of Burkhardt Road), Macomb, Midland, Oakland, Saginaw, St. Clair, The University of Michigan, Washtenaw (east of U.S. 23) & Wayne....	\$ 23.39	21.13
IRONWORKER		
Ornamental and Structural....	\$ 33.78	26.97
Reinforcing.....	\$ 28.30	24.60

-----

IRON0055-005 07/01/2013

LENAWEE AND MONROE COUNTIES:

	Rates	Fringes
IRONWORKER		
Pre-engineered metal buildings.....	\$ 23.59	19.35
All other work.....	\$ 28.32	19.35

IRON0292-003 06/01/2014

BERRIEN AND CASS COUNTIES:

	Rates	Fringes
IRONWORKER (Including pre-engineered metal building erector).....	\$ 27.62	18.66

IRON0340-001 12/01/2013

ALLEGAN, ANTRIM, BARRY, BENZIE, BRANCH, CALHOUN, CHARLEVOIX, EATON, EMMET, GRAND TRAVERSE, HILLSDALE, IONIA, KALAMAZOO, KALKASKA, KENT, LAKE, LEELANAU, MANISTEE, MASON, MECOSTA, MISSAUKEE, MONTCALM, MUSKEGON, NEWAYGO, OCEANA, OSCEOLA, OTTAWA, ST. JOSEPH, VAN BUREN AND WEXFORD COUNTIES:

	Rates	Fringes
IRONWORKER (Including pre-engineered metal building erector).....	\$ 20.68	24.57

LABO0005-006 10/01/2013

	Rates	Fringes
Laborers - hazardous waste abatement: (ALCONA, ALPENA, ANTRIM, BENZIE, CHARLEVOIX, CHEBOYGAN, CRAWFORD, EMMET, GRAND TRAVERSE, IOSCO, KALKASKA, LEELANAU, MISSAUKEE, MONTMORENCY, OSCODA, OTSEGO, PRESQUE ISLE AND WEXFORD COUNTIES - Zone 10)		
Levels A, B or C.....	\$ 17.14	12.46
Work performed in conjunction with site preparation not requiring the use of personal protective equipment; Also, Level D.....	\$ 16.14	12.46
Laborers - hazardous waste abatement: (ALGER, BARAGA, CHIPPEWA, DELTA, DICKINSON, GOGEBIC, HOUGHTON, IRON, KEWEENAW, LUCE, MACKINAC, MARQUETTE, MENOMINEE, ONTONAGON AND SCHOOLCRAFT COUNTIES - Zone 11)		
Levels A, B or C.....	\$ 20.92	12.49

Work performed in conjunction with site preparation not requiring the use of personal protective equipment; Also, Level D.....\$ 19.92	12.49
Laborers - hazardous waste abatement: (ALLEGAN, BARRY, BERRIEN, BRANCH, CALHOUN, CASS, IONIA COUNTY (except the city of Portland); KALAMAZOO, KENT, LAKE, MANISTEE, MASON, MECOSTA, MONTCALM, MUSKEGON, NEWAYGO, OCEANA, OSCEOLA, OTTAWA, ST. JOSEPH AND VAN BUREN COUNTIES - Zone 9)	
Levels A, B or C.....\$ 19.31	12.46
Work performed in conjunction with site preparation not requiring the use of personal protective equipment; Also, Level D.....\$ 18.31	12.46
Laborers - hazardous waste abatement: (ARENAC, BAY, CLARE, GLADWIN, GRATIOT, HURON, ISABELLA, MIDLAND, OGEMAW, ROSCOMMON, SAGINAW AND TUSCOLA COUNTIES - Zone 8)	
Levels A, B or C.....\$ 20.02	12.46
Work performed in conjunction with site preparation not requiring the use of personal protective equipment; Also, Level D.....\$ 19.02	12.46
Laborers - hazardous waste abatement: (CLINTON, EATON AND INGHAM COUNTIES; IONIA COUNTY (City of Portland); LIVINGSTON COUNTY (west of Oak Grove Rd., including the City of Howell) - Zone 6)	
Levels A, B or C.....\$ 22.84	12.46
Work performed in conjunction with site preparation not requiring the use of personal protective equipment; Also, Level D.....\$ 21.84	12.46
Laborers - hazardous waste abatement: (GENESEE, LAPEER AND SHIAWASSEE COUNTIES - Zone 7)	
Levels A, B or C.....\$ 23.35	12.50
Work performed in conjunction with site preparation not requiring the use of personal protective equipment; Also, Level D.....\$ 22.35	12.50



Laborers - hazardous waste		
abatement: (HILLSDALE,		
JACKSON AND LENAWEE COUNTIES		
- Zone 4)		
Levels A, B or C.....\$	22.38	12.46
Work performed in		
conjunction with site		
preparation not requiring		
the use of personal		
protective equipment;		
Also, Level D.....\$	21.38	12.46
Laborers - hazardous waste		
abatement: (LIVINGSTON COUNTY		
(east of Oak Grove Rd. and		
south of M-59, excluding the		
city of Howell); AND		
WASHTENAW COUNTY - Zone 3)		
Levels A, B or C.....\$	28.80	13.42
Work performed in		
conjunction with site		
preparation not requiring		
the use of personal		
protective equipment;		
Also, Level D.....\$	27.80	13.42
Laborers - hazardous waste		
abatement: (MACOMB AND WAYNE		
COUNTIES - Zone 1)		
Levels A, B or C.....\$	27.94	16.55
Work performed in		
conjunction with site		
preparation not requiring		
the use of personal		
protective equipment;		
Also, Level D.....\$	26.94	16.55
Laborers - hazardous waste		
abatement: (MONROE COUNTY -		
Zone 4)		
Levels A, B or C.....\$	29.86	14.23
Work performed in		
conjunction with site		
preparation not requiring		
the use of personal		
protective equipment;		
Also, Level D.....\$	28.86	14.23
Laborers - hazardous waste		
abatement: (OAKLAND COUNTY		
and the Northeast portion of		
LIVINGSTON COUNTY bordered by		
Oak Grove Road on the West		
and M-59 on the South - Zone		
2)		
Level A, B, C.....\$	27.94	16.55
Work performed in		
conjunction with site		
preparation not requiring		
the use of personal		
protective equipment;		
Also, Level D.....\$	26.94	16.55
Laborers - hazardous waste		
abatement: (SANILAC AND ST.		
CLAIR COUNTIES - Zone 5)		
Levels A, B or C.....\$	24.90	14.90

Work performed in  
 conjunction with site  
 preparation not requiring  
 the use of personal  
 protective equipment;  
 Also, Level D.....\$ 23.90 14.90

\* LABO0259-001 09/01/2014

AREA 1: MACOMB, OAKLAND AND WAYNE COUNTIES  
 AREA 2: ALCONA, ALGER, ALLEGAN, ALPENA, ANTRIM, ARENAC, BARAGA,  
 BARRY, BAY, BENZIE, BERRIEN, BRANCH, CALHOUN, CASS, CHARLEVOIX,  
 CHEBOYGAN, CHIPPEWA, CLARE, CLINTON, CRAWFORD, DELTA,  
 DICKINSON, EATON, EMMET, GENESEE, GLADWIN, GOGEBIC, GRAND  
 TRAVERSE, GRATIOT, HILLSDALE, HOUGHTON, HURON, INGHAM, IONIA,  
 IOSCO, IRON, ISABELLA, JACKSON, KALAMAZOO, KALKASKA, KENT,  
 KEWEENAW, LAKE, LAPEER, LEELANAU, LENAWEE, LIVINGSTON, LUCE,  
 MACKINAC, MANISTEE, MARQUETTE, MASON, MECOSTA, MENOMINEE,  
 MIDLAND, MISSAUKEE, MONROE, MONTCALM, MONTMORENCY, MUSKEGON,  
 NEWAYGO, OCEANA, OGEMAW, ONTONAGON, OSCEOLA, OSCODA, OTSEGO,  
 OTTAWA, PRESQUE ISLE, ROSCOMMON, SAGINAW, ST. CLARE, ST.  
 JOSEPH, SANILAC, SCHOOLCRAFT, SHIAWASSEE, TUSCOLA, VAN BUREN,  
 WASHTENAW AND WEXFORD COUNTIES

	Rates	Fringes
Laborers - tunnel, shaft and caisson:		
AREA 1		
GROUP 1.....	\$ 21.57	16.28
GROUP 2.....	\$ 21.68	16.28
GROUP 3.....	\$ 21.74	16.28
GROUP 4.....	\$ 21.92	16.28
GROUP 5.....	\$ 22.17	16.28
GROUP 6.....	\$ 22.50	16.28
GROUP 7.....	\$ 15.78	16.28
AREA 2		
GROUP 1.....	\$ 22.80	12.46
GROUP 2.....	\$ 22.89	12.46
GROUP 3.....	\$ 22.99	12.46
GROUP 4.....	\$ 23.15	12.46
GROUP 5.....	\$ 23.41	12.46
GROUP 6.....	\$ 23.72	12.46
GROUP 7.....	\$ 15.99	12.46

SCOPE OF WORK: Tunnel, shaft and caisson work of every type  
 and description and all operations incidental thereto,  
 including, but not limited to, shafts and tunnels for  
 sewers, water, subways, transportation, diversion,  
 sewerage, caverns, shelters, aquifers, reservoirs, missile  
 silos and steel sheeting for underground construction.

TUNNEL LABORER CLASSIFICATIONS

GROUP 1: Tunnel, shaft and caisson laborer, dump, shanty, hog  
 house tender, testing (on gas) and watchman

GROUP 2: Manhole, headwall, catch basin builder, bricklayer  
 tender, mortar machine and material mixer

GROUP 3: Air tool operator (jackhammer, bush hammer and  
 grinder), first bottom, second bottom, cage tender, car  
 pusher, carrier, concrete, concrete form, concrete repair,

cement invert laborer, cement finisher, concrete shoveler, conveyor, floor, gasoline and electric tool operator, gunite, grout operator, welder, heading dinky person, inside lock tender, pea gravel operator, pump, outside lock tender, scaffold, top signal person, switch person, track, tugging, utility person, vibrator, winch operator, pipe jacking, wagon drill and air track operator and concrete saw operator (under 40 h.p.)

GROUP 4: Tunnel, shaft and caisson mucker, bracer, liner plate, long haul dinky driver and well point

GROUP 5: Tunnel, shaft and caisson miner, drill runner, key board operator, power knife operator, reinforced steel or mesh (e.g. wire mesh, steel mats, dowel bars, etc.)

GROUP 6: Dynamite and powder

GROUP 7: Restoration laborer, seeding, sodding, planting, cutting, mulching and top soil grading; and the restoration of property such as replacing mailboxes, wood chips, planter boxes, flagstones, etc.

-----  
 \* LABO0334-001 09/01/2014

	Rates	Fringes
Laborers - open cut:		
ZONE 1 - MACOMB, OAKLAND AND WAYNE COUNTIES:		
GROUP 1.....	\$ 21.42	16.28
GROUP 2.....	\$ 21.53	16.28
GROUP 3.....	\$ 21.58	16.28
GROUP 4.....	\$ 21.66	16.28
GROUP 5.....	\$ 21.72	16.28
GROUP 6.....	\$ 19.17	16.28
GROUP 7.....	\$ 15.79	16.28
ZONE 2 - LIVINGSTON COUNTY (east of M-151 (Oak Grove Rd.)); MONROE AND WASHTENAW COUNTIES:		
GROUP 1.....	\$ 22.45	12.46
GROUP 2.....	\$ 22.56	12.46
GROUP 3.....	\$ 22.68	12.46
GROUP 4.....	\$ 22.75	12.46
GROUP 5.....	\$ 22.90	12.46
GROUP 6.....	\$ 20.20	12.46
GROUP 7.....	\$ 16.84	12.46
ZONE 3 - CLINTON, EATON, GENESEE, HILLSDALE AND INGHAM COUNTIES; IONIA COUNTY (City of Portland); JACKSON, LAPEER AND LENAWEE COUNTIES; LIVINGSTON COUNTY (west of M-151 Oak Grove Rd.); SANILAC, ST. CLAIR AND SHIAWASSEE COUNTIES:		
GROUP 1.....	\$ 20.64	12.46
GROUP 2.....	\$ 20.78	12.46
GROUP 3.....	\$ 20.90	12.46
GROUP 4.....	\$ 20.95	12.46
GROUP 5.....	\$ 21.09	12.46

GROUP 6.....	\$ 18.39	12.46
GROUP 7.....	\$ 15.54	12.46
ZONE 4 - ALCONA, ALLEGAN, ALPENA, ANTRIM, ARENAC, BARRY, BAY, BENZIE, BERRIEN, BRANCH, CALHOUN, CASS, CHARLEVOIX, CHEBOYGAN, CLARE, CRAWFORD, EMMET, GLADWIN, GRAND TRAVERSE, GRATIOT AND HURON COUNTIES; IONIA COUNTY (EXCEPT THE CITY OF PORTLAND); IOSCO, ISABELLA, KALAMAZOO, KALKASKA, KENT, LAKE, LEELANAU, MANISTEE, MASON, MECOSTA, MIDLAND, MISSAUKEE, MONTCALM, MONTMORENCY, MUSKEGON, NEWAYGO, OCEANA, OGEMAW, OSCEOLA, OSCODA, OTSEGO, OTTAWA, PRESQUE ISLE, ROSCOMMON, SAGINAW, ST. JOSEPH, TUSCOLA, VAN BUREN AND WEXFORD COUNTIES:		
GROUP 1.....	\$ 19.65	12.46
GROUP 2.....	\$ 19.78	12.46
GROUP 3.....	\$ 19.89	12.46
GROUP 4.....	\$ 19.96	12.46
GROUP 5.....	\$ 20.08	12.46
GROUP 6.....	\$ 17.30	12.46
GROUP 7.....	\$ 15.64	12.46
ZONE 5 - ALGER, BARAGA, CHIPPEWA, DELTA, DICKINSON, GOGEBIC, HOUGHTON, IRON, KEWEENAW, LUCE, MACKINAC, MARQUETTE, MENOMINEE, ONTONAGON AND SCHOOLCRAFT COUNTIES:		
GROUP 1.....	\$ 19.86	12.46
GROUP 2.....	\$ 20.00	12.46
GROUP 3.....	\$ 20.13	12.46
GROUP 4.....	\$ 20.18	12.46
GROUP 5.....	\$ 20.23	12.46
GROUP 6.....	\$ 17.61	12.46
GROUP 7.....	\$ 15.72	12.46

SCOPE OF WORK:

Open cut construction work shall be construed to mean work which requires the excavation of earth including industrial, commercial and residential building site excavation and preparation, land balancing, demolition and removal of concrete and underground appurtenances, grading, paving, sewers, utilities and improvements; retention, oxidation, flocculation and irrigation facilities, and also including but not limited to underground piping, conduits, steel sheeting for underground construction, and all work incidental thereto, and general excavation. For all areas except the Upper Peninsula, open cut construction work shall also be construed to mean waterfront work, piers,

docks, seawalls, breakwalls, marinas and all incidental work. Open cut construction work shall not include any structural modifications, alterations, additions and repairs to buildings, or highway work, including roads, streets, bridge construction and parking lots or steel erection work and excavation for the building itself and back filling inside of and within 5 ft. of the building and foundations, footings and piers for the building. Open cut construction work shall not include any work covered under Tunnel, Shaft and Caisson work.

#### OPEN CUT LABORER CLASSIFICATIONS

##### GROUP 1: Construction laborer

GROUP 2: Mortar and material mixer, concrete form person, signal person, well point person, manhole, headwall and catch basin builder, headwall, seawall, breakwall and dock builder

GROUP 3: Air, gasoline and electric tool operator, vibrator operator, driller, pump person, tar kettle operator, bracer, rodder, reinforced steel or mesh person (e.g., wire mesh, steel mats, dowel bars, etc.), welder, pipe jacking and boring person, wagon drill and air track operator and concrete saw operator (under 40 h.p.), windlass and tugger person and directional boring person

##### GROUP 4: Trench or excavating grade person

GROUP 5: Pipe layer (including crock, metal pipe, multi-plate or other conduits)

GROUP 6: Grouting man, audio-visual television operations and all other operations in connection with closed circuit television inspection, pipe cleaning and pipe relining work and the installation and repair of water service pipe and appurtenances

GROUP 7: Restoration laborer, seeding, sodding, planting, cutting, mulching and top soil grading; and the restoration of property such as replacing mailboxes, wood chips, planter boxes, flagstones, etc.

---

LABO0465-001 06/01/2014

LABORER: Highway, Bridge and Airport Construction

AREA 1: GENESEE, MACOMB, MONROE, OAKLAND, WASHTENAW AND WAYNE COUNTIES

AREA 2: ALLEGAN, BARRY, BAY, BERRIEN, BRANCH, CALHOUN, CASS, CLINTON, EATON, GRATIOT, HILLSDALE, HURON, INGHAM, JACKSON, KALAMAZOO, LAPEER, LENAWEE, LIVINGSTON, MIDLAND, MUSKEGON, SAGINAW, SANILAC, SHIAWASSEE, ST. CLAIR, ST. JOSEPH, TUSCOLA AND VAN BUREN COUNTIES

AREA 3: ALCONA, ALPENA, ANTRIM, ARENAC, BENZIE, CHARLEVOIX, CHEBOYGAN, CLARE, CRAWFORD, EMMET, GLADWIN, GRAND TRAVERSE, IONIA, IOSCO, ISABELLA, KALKASKA, KENT, LAKE, LEELANAU, MANISTEE, MASON, MECOSTA, MISSAUKEE, MONTCALM, MONTMORENCY, NEWAYGO, OCEANA, OGEAW, OSCEOLA, OSCODA, OTSEGO, OTTAWA,

PRESQUE ISLE, ROSCOMMON AND WEXFORD COUNTIES

AREA 4: ALGER, BARAGA, CHIPPEWA, DELTA, DICKINSON, GOGEBIC,  
HOUGHTON, IRON, KEWEENAW, LUCE, MACKINAC, MARQUETTE, MENOMINEE,  
ONTONAGON AND SCHOOLCRAFT COUNTIES

	Rates	Fringes
LABORER (AREA 1)		
GROUP 1.....	\$ 24.71	12.75
GROUP 2.....	\$ 24.84	12.75
GROUP 3.....	\$ 25.05	12.75
GROUP 4.....	\$ 25.10	12.75
GROUP 5.....	\$ 25.31	12.75
GROUP 6.....	\$ 25.61	12.75
LABORER (AREA 2)		
GROUP 1.....	\$ 22.71	12.75
GROUP 2.....	\$ 22.91	12.75
GROUP 3.....	\$ 23.15	12.75
GROUP 4.....	\$ 23.50	12.75
GROUP 5.....	\$ 22.37	12.75
GROUP 6.....	\$ 23.71	12.75
LABORER (AREA 3)		
GROUP 1.....	\$ 21.96	12.75
GROUP 2.....	\$ 22.17	12.75
GROUP 3.....	\$ 22.46	12.75
GROUP 4.....	\$ 22.90	12.75
GROUP 5.....	\$ 22.32	12.75
GROUP 6.....	\$ 22.95	12.75
LABORER (AREA 4)		
GROUP 1.....	\$ 21.96	12.75
GROUP 2.....	\$ 22.17	12.75
GROUP 3.....	\$ 22.46	12.75
GROUP 4.....	\$ 22.90	12.75
GROUP 5.....	\$ 22.52	12.75
GROUP 6.....	\$ 22.95	12.75

LABORER CLASSIFICATIONS

GROUP 1: Asphalt shoveler or loader; asphalt plant misc.; burlap person; yard person; dumper (wagon, truck, etc.); joint filling laborer; miscellaneous laborer; unskilled laborer; sprinkler laborer; form setting laborer; form stripper; pavement reinforcing; handling and placing (e.g., wire mesh, steel mats, dowel bars); mason's tender or bricklayer's tender on manholes; manhole builder; headwalls, etc.; waterproofing, (other than buildings) seal coating and slurry mix, shoring, underpinning; pressure grouting; bridge pin and hanger removal; material recycling laborer; horizontal paver laborer (brick, concrete, clay, stone and asphalt); ground stabilization and modification laborer; grouting; waterblasting; top person; railroad track and trestle laborer; carpenters' tender; guard rail builders' tender; earth retention barrier and wall and M.S.E. wall installer's tender; highway and median installer's tender (including sound, retaining, and crash barriers); fence erector's tender; asphalt raker tender; sign installer; remote control operated equipment.

GROUP 2: Mixer operator (less than 5 sacks); air or electric tool operator (jackhammer, etc.); spreader; boxperson (asphalt, stone, gravel); concrete paddler; power chain saw operator; paving batch truck dumper; tunnel mucker (highway work only); concrete saw (under 40 h.p.) and dry pack

machine; roto-mill grounds person.

GROUP 3: Tunnel miner (highway work only); finishers tenders; guard rail builders; highway and median barrier installer; earth retention barrier and wall and M.S.E. wall installer's (including sound, retaining and crash barriers); fence erector; bottom person; powder person; wagon drill and air track operator; diamond and core drills; grade checker; certified welders; curb and side rail setter's tender.

GROUP 4: Asphalt raker

GROUP 5: Pipe layers, oxy-gun

GROUP 6: Line-form setter for curb or pavement; asphalt screed checker/screw man on asphalt paving machines.

-----  
LABO1076-005 04/01/2014

MICHIGAN STATEWIDE

	Rates	Fringes
LABORER (DISTRIBUTION WORK)		
Zone 1.....	\$ 19.17	12.75
Zone 2.....	\$ 17.62	12.75
Zone 3.....	\$ 15.85	12.75
Zone 4.....	\$ 15.22	12.75
Zone 5.....	\$ 15.22	12.75

DISTRIBUTION WORK - The construction, installation, treating and reconditioning of distribution pipelines transporting coal, oil, gas or other similar materials, vapors or liquids, including pipelines within private property boundaries, up to and including the meter settings on residential, commercial, industrial, institutional, private and public structures. All work covering pumping stations and tank farms not covered by the Building Trades Agreement. Other distribution lines with the exception of sewer, water and cable television are included.

Underground Duct Layer Pay: \$.40 per hour above the base pay rate.

- Zone 1 - Macomb, Oakland and Wayne
- Zone 2 - Monroe and Washtenaw
- Zone 3 - Bay, Genesee, Lapeer, Midland, Saginaw, Sanilac, Shiawassee and St. Clair
- Zone 4 - Alger, Baraga, Chippewa, Delta, Dickinson, Gogebic, Houghton, Iron, Keweenaw, Luce, Mackinac, Marquette, Menominee, Ontonagon and Schoolcraft
- Zone 5 - Remaining Counties in Michigan

-----  
PAIN0022-002 07/01/2008

HILLSDALE, JACKSON AND LENAWEE COUNTIES; LIVINGSTON COUNTY (east of the eastern city limits of Howell, not including the city of Howell, north to the Genesee County line and south to the Washtenaw County line); MACOMB, MONROE, OAKLAND, WASHTENAW AND WAYNE COUNTIES:

	Rates	Fringes
PAINTER.....	\$ 25.06	14.75

FOOTNOTES: For all spray work and journeyman rigging for spray work, also blowing off, \$0.80 per hour additional (applies only to workers doing rigging for spray work on off the floor work. Does not include setting up or moving rigging on floor surfaces, nor does it apply to workers engaged in covering up or tending spray equipment. For all sandblasting and spray work performed on highway bridges, overpasses, tanks or steel, \$0.80 per hour additional. For all brushing, cleaning and other preparatory work (other than spraying or steeplejack work) at scaffold heights of fifty (50) feet from the ground or higher, \$0.50 per hour additional. For all preparatorial work and painting performed on open steel under forty (40) feet when no scaffolding is involved, \$0.50 per hour additional. For all swing stage work-window jacks and window belts-exterior and interior, \$0.50 per hour additional. For all spray work and sandblaster work to a scaffold height of forty (40) feet above the floor level, \$0.80 per hour additional. For all preparatorial work and painting on all highway bridges or overpasses up to forty (40) feet in height, \$0.50 per hour additional. For all steeplejack work performed where the elevation is forty (40) feet or more, \$1.25 per hour additional.

-----  
PAIN0312-001 06/12/2014

EXCLUDES: ALLEGAN COUNTY (Townships of Dorr, Fillmore, Heath, Hopkins, Laketown, Leighton, Manlius, Monterey, Overisel, Salem, Saugatuck and Wayland); INCLUDES: Barry, Berrien, Branch, Calhoun, Cass, Hillsdale, Kalamazoo, St. Joseph, Van Buren

	Rates	Fringes
PAINTER		
Brush and roller.....	\$ 21.75	11.94
Spray, Sandblast, Sign		
Painting.....	\$ 22.75	11.94

-----  
PAIN0845-003 05/21/2014

CLINTON COUNTY; EATON COUNTY (does not include the townships of Bellevue and Olivet); INGHAM COUNTY; IONIA COUNTY (east of Hwy. M 66); LIVINGSTON COUNTY (west of the eastern city limits of Howell, including the city of Howell, north to the Genesee County line and south to the Washtenaw County line); AND SHIAWASSEE COUNTY (Townships of Bennington, Laingsbury and Perry):

	Rates	Fringes
PAINTER.....	\$ 21.89	11.85

-----  
PAIN0845-015 05/21/2014

MUSKEGON COUNTY; NEWAYGO COUNTY (except the Townships of Barton, Big Prairie, Brooks, Croton, Ensley, Everett, Goodwell, Grant, Home, Monroe, Norwich and Wilcox); OCEANA COUNTY; OTTAWA



COUNTY (except the townships of Allendale, Blendone, Chester, Georgetown, Holland, Jamestown, Olive, Park, Polkton, Port Sheldon, Tallmadge, Wright and Zeeland):

	Rates	Fringes
PAINTER.....	\$ 21.89	11.85
-----		
PAIN0845-018 05/21/2014		

ALLEGAN COUNTY (Townships of Dorr, Fillmore, Heath, Hopkins, Laketown, Leighton, Manlius, Monterey, Overisel, Salem, Saugatuck and Wayland); IONIA COUNTY (west of Hwy. M-66); KENT, MECOSTA AND MONTCALM COUNTIES; NEWAYGO COUNTY (Townships of Barton, Big Prairie, Brooks, Croton, Ensley, Everett, Goodwell, Grant, Home, Monroe, Norwich and Wilcox); OSCEOLA COUNTY (south of Hwy. #10); OTTAWA COUNTY (Townships of Allendale, Blendone, Chester, Georgetown, Holland, Jamestown, Olive, Park, Polkton, Port Sheldon, Tallmadge, Wright and Zeeland):

	Rates	Fringes
PAINTER.....	\$ 21.89	11.85
-----		
PAIN1011-003 06/05/2014		

ALGER, BARAGA, CHIPPEWA, DELTA, DICKINSON, GOGEBIC, HOUGHTON, IRON, KEWEENAW, LUCE, MACKINAC, MARQUETTE, MENOMINEE, ONTONAGON AND SCHOOLCRAFT COUNTIES:

	Rates	Fringes
PAINTER.....	\$ 24.15	10.52
-----		
FOOTNOTES: High pay (bridges, overpasses, watertower): 30 to 80 ft.: \$.65 per hour additional. 80 ft. and over: \$1.30 per hour additional.		
-----		
PAIN1474-002 06/01/2010		

HURON COUNTY; LAPEER COUNTY (east of Hwy. M-53); ST. CLAIR, SANILAC AND TUSCOLA COUNTIES:

	Rates	Fringes
PAINTER.....	\$ 23.79	12.02
-----		

FOOTNOTES: Lead abatement work: \$1.00 per hour additional. Work with any hazardous material: \$1.00 per hour additional. Sandblasting, steam cleaning and acid cleaning: \$1.00 per hour additional. Ladder work at or above 40 ft., scaffold work at or above 40 ft., swing stage, boatswain chair, window jacks and all work performed over a falling height of 40 ft.: \$1.00 per hour additional. Spray gun work, pick pullers and those handling needles, blowing off by air pressure, and any person rigging (setting up and moving off the ground): \$1.00 per hour additional. Steeplejack, tanks, gas holders, stacks, flag poles, radio towers and beacons, power line towers, bridges, etc.: \$1.00 per hour additional, paid from the ground up.

ALCONA, ALPENA, ANTRIM, ARENAC, BAY, BENZIE, CHARLEVOIX, CHEBOYGAN, CLARE, CRAWFORD, EMMET, GLADWIN, GRAND TRAVERSE, GRATIOT, IOSCO, ISABELLA, KALKASKA, LAKE, LEELANAU, MANISTEE, MASON, MIDLAND, MISSAUKEE, MONTMORENCY AND OGEMAW COUNTIES; OSCEOLA COUNTY (north of Hwy. #10); OSCODA, OTSEGO, PRESQUE ISLE, ROSCOMMON, SAGINAW AND WEXFORD COUNTIES:

	Rates	Fringes
PAINTER		
Work performed on water, bridges over water or moving traffic, radio and powerline towers, elevated tanks, steeples, smoke stacks over 40 ft. of falling heights, recovery of lead-based paints and any work associated with industrial plants, except maintenance of industrial plants.....	\$ 24.00	12.8
All other work, including maintenance of industrial plant.....	\$ 22.58	12.80

FOOTNOTES: Spray painting, sandblasting, blowdown associated with spraying and blasting, water blasting and work involving a swing stage, boatswain chair or spider: \$1.00 per hour additional. All work performed inside tanks, vessels, tank trailers, railroad cars, sewers, smoke stacks, boilers or other spaces having limited egress not including buildings, opentop tanks, pits, etc.: \$1.25 per hour additional.

ZONE 1: GENESEE, LIVINGSTON, MACOMB, MONROE, OAKLAND, SAGINAW, WASHTENAW AND WAYNE COUNTIES

ZONE 2: ALCONA, ALGER, ALLEGAN, ALPENA, ANTRIM, ARENAC, BARAGA, BARRY, BAY, BENZIE, BERRIEN, BRANCH, CALHOUN, CASS, CHARLEVOIX, CHEBOYGAN, CHIPPEWA, CLARE, CLINTON, CRAWFORD, DELTA, DICKINSON, EATON, EMMET, GLADWIN, GOGEBIC, GRAND TRAVERSE, GRATIOT, HILLSDALE, HOUGHTON, HURON, INGHAM, IONIA, IOSCO, IRON, ISABELLA, JACKSON, KALAMAZOO, KALKASKA, KENT, KEWEENAW, LAKE, LAPEER, LEELANAU, LENAWEE, LUCE, MACKINAC, MANISTEE, MARQUETTE, MASON, MECOSTA, MENOMINEE, MIDLAND, MISSAUKEE, MONTCALM, MONTMORENCY, MUSKEGON, NEWAYGO, OCEANA, OGEMAW, ONTONAGON, OSCEOLA, OSCODA, OTSEGO, OTTAWA, PRESQUE ISLE, ROSCOMMON, SANILAC, SCHOOLCRAFT, SHIAWASSEE, ST. CLAIR, ST. JOSEPH, TUSCOLA, VAN BUREN AND WEXFORD COUNTIES

	Rates	Fringes
CEMENT MASON/CONCRETE FINISHER		
ZONE 1.....	\$ 29.59	12.59
ZONE 2.....	\$ 28.29	12.59

-----

ALCONA, ALGER, ALLEGAN, ALPENA, ANTRIM, ARENAC, BARAGA, BARRY, BAY, BENZIE, BERRIEN, BRANCH, CALHOUN, CASS, CHARLEVOIX, CHEBOYGAN, CHIPPEWA, CLARE, CLINTON, CRAWFORD, DELTA, DICKINSON, EATON, EMMET, GENESEE, GLADWIN, GOGEBIC, GRAND TRAVERSE, GRATIOT, HILLSDALE, HOUGHTON, HURON, INGHAM, IONIA, IOSCO, IRON, ISABELLA, JACKSON, KALAMAZOO, KALKASKA, KENT, KEWEENAW, LAKE, LAPEER, LEELANAU, LENAWEE, LIVINGSTON, LUCE, MACKINAC, MACOMB, MANISTEE, MARQUETTE, MASON, MECOSTA, MENOMINEE, MIDLAND, MISSAUKEE, MONTCALM, MONTMORENCY, MONROE, MUSKEGON, NEWAYGO, OAKLAND, OCEANA, OGEMAW, ONTONAGON, OSCEOLA, OSCODA, OTSEGO, OTTAWA, PRESQUE ISLE, ROSCOMMON, SAGINAW, ST. CLARE, ST. JOSEPH, SANILAC, SCHOOLCRAFT, SHIAWASSEE, TUSCOLA, VAN BUREN, WASHTENAW, WAYNE AND WEXFORD COUNTIES

	Rates	Fringes
Plumber/Pipefitter - gas distribution pipeline:		
Welding in conjunction with gas distribution pipeline work.....	\$ 31.73	19.96
All other work:.....	\$ 20.72	11.15

-----  
TEAM0007-004 06/01/2014

AREA 1: ALCONA, ALGER, ALLEGAN, ALPENA, ANTRIM, ARENAC, BARAGA, BARRY, BAY, BENZIE, BERRIEN, BRANCH, CALHOUN, CASS, CHARLEVOIX, CHEBOYGAN, CHIPPEWA, CLARE, CLINTON, CRAWFORD, DELTA, DICKINSON, EATON, EMMET, GLADWIN, GOGEBIC, GRAND TRAVERSE, GRATIOT, HILLSDALE, HOUGHTON, HURON, INGHAM, IONIA, IOSCO, IRON, ISABELLA, JACKSON, KALAMAZOO, KALKASKA, KENT, KEWEENAW, LAKE, LAPEER, LEELANAU, LENAWEE, LUCE, MACKINAC, MANISTEE, MARQUETTE, MASON, MECOSTA, MENOMINEE, MIDLAND, MISSAUKEE, MONTCALM, MONTMORENCY, MUSKEGON, NEWAYGO, OCEANA, OGEMAW, ONTONAGON, OSCEOLA, OSCODA, OTSEGO, OTTAWA, PRESQUE ISLE, ROSCOMMON, SAGINAW, SANILAC, SCHOOLCRAFT, SHIAWASSEE, ST. CLAIR, ST. JOSEPH, TUSCOLA, VAN BUREN AND WEXFORD COUNTIES

AREA 2: GENESEE, LIVINGSTON, MACOMB, MONROE, OAKLAND, WASHTENAW AND WAYNE COUNTIES

	Rates	Fringes
TRUCK DRIVER		
AREA 1		
Euclids, double bottoms and lowboys.....	\$ 25.05	.50 + a+b
Trucks under 8 cu. yds.....	\$ 24.80	.50 + a+b
Trucks, 8 cu. yds. and over.....	\$ 24.90	.50 + a+b
AREA 2		
Euclids, double bottomms and lowboys.....	\$ 24.895	.50 + a+b
Euclids, double bottoms and lowboys.....	\$ 25.15	.50 + a+b
Trucks under 8 cu. yds.....	\$ 24.90	.50 + a+b
Trucks, 8 cu. yds. and over.....	\$ 25.00	.50 + a+b

Footnote:  
a. \$395.05 per week  
b. \$56.10 daily

AREA 1: ALCONA, ALGER, ALLEGAN, ALPENA, ANTRIM, ARENAC, BARAGA, BARRY, BAY, BENZIE, BERRIEN, BRANCH, CALHOUN, CASS, CHARLEVOIX, CHEBOYGAN, CHIPPEWA, CLARE, CLINTON, CRAWFORD, DELTA, DICKINSON, EATON, EMMET, GLADWIN, GOGEBIC, GRAND TRAVERSE, GRATIOT, HILLSDALE, HOUGHTON, HURON, INGHAM, IONIA, IOSCO, IRON, ISABELLA, JACKSON, KALAMAZOO, KALKASKA, KENT, KEWEENAW, LAKE, LAPEER, LEELANAU, LENAWEE, LUCE, MACKINAC, MANISTEE, MARQUETTE, MASON, MECOSTA, MENOMINEE, MIDLAND, MISSAUKEE, MONTCALM, MONTMORENCY, MUSKEGON, NEWAYGO, OCEANA, OGEMAW, ONTONAGON, OSCEOLA, OSCODA, OTSEGO, OTTAWA, PRESQUE ISLE, ROSCOMMON, SANILAC, SCHOOLCRAFT, SHIAWASSEE, SAGINAW, ST. CLAIR, ST. JOSEPH, TUSCOLA, VAN BUREN AND WEXFORD COUNTIES

AREA 2: GENESEE, LIVINGSTON, MACOMB, MONROE, OAKLAND, WASHTENAW AND WAYNE COUNTIES

	Rates	Fringes
Sign Installer		
AREA 1		
GROUP 1.....	\$ 20.18	.15 + a
GROUP 2.....	\$ 19.93	.15 + a
AREA 2		
GROUP 1.....	\$ 21.73	.15 + a
GROUP 2.....	\$ 21.48	.15 + a

FOOTNOTE:

a. \$132.70 per week, plus \$17.80 per day.

SIGN INSTALLER CLASSIFICATIONS:

GROUP 1: performs all necessary labor and uses all tools required to construct and set concrete forms required in the installation of highway and street signs

GROUP 2: performs all miscellaneous labor, uses all hand and power tools, and operates all other equipment, mobile or otherwise, required for the installation of highway and street signs

AREA 1: LAPEER AND SHIAWASSEE COUNTIES

AREA 2: GENESEE, MACOMB, MONROE, OAKLAND, ST. CLAIR, WASHTENAW AND WAYNE COUNTIES

	Rates	Fringes
TRUCK DRIVER (Underground construction)		
AREA 1		
GROUP 1.....	\$ 21.97358.65/wk+55.00/day	
GROUP 2.....	\$ 22.06358.65/wk+55.00/day	
GROUP 3.....	\$ 22.27358.65/wk+55.00/day	
AREA 2		
GROUP 1.....	\$ 22.27358.65/wk+55.00/day	
GROUP 2.....	\$ 22.41358.65/wk+55.00/day	
GROUP 3.....	\$ 22.60358.65/wk+55.00/day	

PAID HOLIDAYS: New Year's Day, Memorial Day, Fourth of July, Labor Day, Thanksgiving Day and Christmas Day.

SCOPE OF WORK: Excavation, site preparation, land balancing, grading, sewers, utilities and improvements; also including but not limited to, tunnels, underground piping, retention, oxidation, flocculation facilities, conduits, general excavation and steel sheeting for underground construction. Underground construction work shall not include any structural modifications, alterations, additions and repairs to buildings or highway work, including roads, streets, bridge construction and parking lots or steel erection.

TRUCK DRIVER CLASSIFICATIONS

GROUP 1: Truck driver on all trucks (EXCEPT dump trucks of 8 cubic yards capacity or over, pole trailers, semis, low boys, Euclid, double bottom and fuel trucks)

GROUP 2: Truck driver on dump trucks of 8 cubic yards capacity or over, pole trailers, semis and fuel trucks

GROUP 3: Truck driver on low boy, Euclid and double bottom

-----  
SUMI2002-001 05/01/2002

	Rates	Fringes
Flag Person.....	\$ 18.99	12.75
LINE PROTECTOR (ZONE 1: GENESEE, MACOMB, MONROE, OAKLAND, WASHTENAW AND WAYNE)....	\$ 18.98	12.17
LINE PROTECTOR (ZONE 2: STATEWIDE (EXCLUDING GENESEE, MACOMB, MONROE, OAKLAND, WASHTENAW AND WAYNE).....	\$ 17.14	12.17
Pavement Marking Machine (ZONE 1: GENESEE, MACOMB, MONROE, OAKLAND, WASHTENAW AND WAYNE COUNTIES) Group 1.....	\$ 24.89	12.17
Pavement Marking Machine (ZONE 1: GENESEE, MACOMB, MONROE, OAKLAND, WASHTENAW AND WAYNE) Group 2.....	\$ 22.40	12.17
Pavement Marking Machine (ZONE 2: STATEWIDE (EXCLUDING GENESEE, MACOMB, MONROE, OAKLAND, WASHTENAW AND WAYNE COUNTIES) Group 1.....	\$ 22.89	12.17
Pavement Marking Machine (ZONE 2: STATEWIDE (EXCLUDING GENESEE, MACOMB, MONROE,		

OAKLAND, WASHTENAW AND WAYNE)

Group 2.....\$ 20.60

12.17

WORK CLASSIFICATIONS:

PAVEMENT MARKER GROUP 1: Drives or operates a truck mounted striper, grinder, blaster, groover, or thermoplastic melter for the placement or removal of temporary or permanent pavement markings or markers.

PAVEMENT MARKER GROUP 2: Performs all functions involved for the placement or removal of temporary or permanent pavement markings or markers not covered by the classification of Pavement Marker Group 1 or Line Protector.

LINE PROTECTOR: Performs all operations for the protection or removal of temporary or permanent pavement markings or markers in a moving convoy operation not performed by the classification of Pavement Marker Group 1. A moving convoy operation is comprised of only Pavement Markers Group 1 and Line Protectors.

-----

WELDERS - Receive rate prescribed for craft performing operation to which welding is incidental.

=====

Unlisted classifications needed for work not included within the scope of the classifications listed may be added after award only as provided in the labor standards contract clauses (29CFR 5.5 (a) (1) (ii)).

-----

The body of each wage determination lists the classification and wage rates that have been found to be prevailing for the cited type(s) of construction in the area covered by the wage determination. The classifications are listed in alphabetical order of "identifiers" that indicate whether the particular rate is union or non-union.

Union Identifiers

An identifier enclosed in dotted lines beginning with characters other than "SU" denotes that the union classification and rate have found to be prevailing for that classification. Example: PLUM0198-005 07/01/2011. The first four letters , PLUM, indicate the international union and the four-digit number, 0198, that follows indicates the local union number or district council number where applicable , i.e., Plumbers Local 0198. The next number, 005 in the example, is an internal number used in processing the wage determination. The date, 07/01/2011, following these characters is the effective date of the most current negotiated rate/collective bargaining agreement which would be July 1, 2011 in the above example.

Union prevailing wage rates will be updated to reflect any changes in the collective bargaining agreements governing the rates.

0000/9999: weighted union wage rates will be published annually each January.

#### Non-Union Identifiers

Classifications listed under an "SU" identifier were derived from survey data by computing average rates and are not union rates; however, the data used in computing these rates may include both union and non-union data. Example: SULA2004-007 5/13/2010. SU indicates the rates are not union majority rates, LA indicates the State of Louisiana; 2004 is the year of the survey; and 007 is an internal number used in producing the wage determination. A 1993 or later date, 5/13/2010, indicates the classifications and rates under that identifier were issued as a General Wage Determination on that date.

Survey wage rates will remain in effect and will not change until a new survey is conducted.

---

#### WAGE DETERMINATION APPEALS PROCESS

1.) Has there been an initial decision in the matter? This can be:

- \* an existing published wage determination
- \* a survey underlying a wage determination
- \* a Wage and Hour Division letter setting forth a position on a wage determination matter
- \* a conformance (additional classification and rate) ruling

On survey related matters, initial contact, including requests for summaries of surveys, should be with the Wage and Hour Regional Office for the area in which the survey was conducted because those Regional Offices have responsibility for the Davis-Bacon survey program. If the response from this initial contact is not satisfactory, then the process described in 2.) and 3.) should be followed.

With regard to any other matter not yet ripe for the formal process described here, initial contact should be with the Branch of Construction Wage Determinations. Write to:

Branch of Construction Wage Determinations  
Wage and Hour Division  
U.S. Department of Labor  
200 Constitution Avenue, N.W.  
Washington, DC 20210

2.) If the answer to the question in 1.) is yes, then an interested party (those affected by the action) can request review and reconsideration from the Wage and Hour Administrator (See 29 CFR Part 1.8 and 29 CFR Part 7). Write to:

Wage and Hour Administrator  
U.S. Department of Labor  
200 Constitution Avenue, N.W.  
Washington, DC 20210

The request should be accompanied by a full statement of the interested party's position and by any information (wage

payment data, project description, area practice material, etc.) that the requestor considers relevant to the issue.

3.) If the decision of the Administrator is not favorable, an interested party may appeal directly to the Administrative Review Board (formerly the Wage Appeals Board). Write to:

Administrative Review Board  
U.S. Department of Labor  
200 Constitution Avenue, N.W.  
Washington, DC 20210

4.) All decisions by the Administrative Review Board are final.

=====

END OF GENERAL DECISION



**REQUIRED CONTRACT PROVISIONS  
FEDERAL-AID CONSTRUCTION CONTRACTS**

- I. General
- II. Nondiscrimination
- III. Nonsegregated Facilities
- IV. Davis-Bacon and Related Act Provisions
- V. Contract Work Hours and Safety Standards Act Provisions
- VI. Subletting or Assigning the Contract
- VII. Safety: Accident Prevention
- VIII. False Statements Concerning Highway Projects
- IX. Implementation of Clean Air Act and Federal Water Pollution Control Act
- X. Compliance with Governmentwide Suspension and Debarment Requirements
- XI. Certification Regarding Use of Contract Funds for Lobbying

**ATTACHMENTS**

A. Employment and Materials Preference for Appalachian Development Highway System or Appalachian Local Access Road Contracts (included in Appalachian contracts only)

**I. GENERAL**

1. Form FHWA-1273 must be physically incorporated in each construction contract funded under Title 23 (excluding emergency contracts solely intended for debris removal). The contractor (or subcontractor) must insert this form in each subcontract and further require its inclusion in all lower tier subcontracts (excluding purchase orders, rental agreements and other agreements for supplies or services).

The applicable requirements of Form FHWA-1273 are incorporated by reference for work done under any purchase order, rental agreement or agreement for other services. The prime contractor shall be responsible for compliance by any subcontractor, lower-tier subcontractor or service provider.

Form FHWA-1273 must be included in all Federal-aid design-build contracts, in all subcontracts and in lower tier subcontracts (excluding subcontracts for design services, purchase orders, rental agreements and other agreements for supplies or services). The design-builder shall be responsible for compliance by any subcontractor, lower-tier subcontractor or service provider.

Contracting agencies may reference Form FHWA-1273 in bid proposal or request for proposal documents, however, the Form FHWA-1273 must be physically incorporated (not referenced) in all contracts, subcontracts and lower-tier subcontracts (excluding purchase orders, rental agreements and other agreements for supplies or services related to a construction contract).

2. Subject to the applicability criteria noted in the following sections, these contract provisions shall apply to all work performed on the contract by the contractor's own organization and with the assistance of workers under the contractor's immediate superintendence and to all work performed on the contract by piecework, station work, or by subcontract.

3. A breach of any of the stipulations contained in these Required Contract Provisions may be sufficient grounds for withholding of progress payments, withholding of final payment, termination of the contract, suspension / debarment or any other action determined to be appropriate by the contracting agency and FHWA.

4. Selection of Labor: During the performance of this contract, the contractor shall not use convict labor for any purpose within the limits of a construction project on a Federal-aid highway unless it is labor performed by convicts who are on parole, supervised release, or probation. The term Federal-aid highway does not include roadways functionally classified as local roads or rural minor collectors.

**II. NONDISCRIMINATION**

The provisions of this section related to 23 CFR Part 230 are applicable to all Federal-aid construction contracts and to all related construction subcontracts of \$10,000 or more. The provisions of 23 CFR Part 230 are not applicable to material supply, engineering, or architectural service contracts.

In addition, the contractor and all subcontractors must comply with the following policies: Executive Order 11246, 41 CFR 60, 29 CFR 1625-1627, Title 23 USC Section 140, the Rehabilitation Act of 1973, as amended (29 USC 794), Title VI of the Civil Rights Act of 1964, as amended, and related regulations including 49 CFR Parts 21, 26 and 27; and 23 CFR Parts 200, 230, and 633.

The contractor and all subcontractors must comply with: the requirements of the Equal Opportunity Clause in 41 CFR 60-1.4(b) and, for all construction contracts exceeding \$10,000, the Standard Federal Equal Employment Opportunity Construction Contract Specifications in 41 CFR 60-4.3.

Note: The U.S. Department of Labor has exclusive authority to determine compliance with Executive Order 11246 and the policies of the Secretary of Labor including 41 CFR 60, and 29 CFR 1625-1627. The contracting agency and the FHWA have the authority and the responsibility to ensure compliance with Title 23 USC Section 140, the Rehabilitation Act of 1973, as amended (29 USC 794), and Title VI of the Civil Rights Act of 1964, as amended, and related regulations including 49 CFR Parts 21, 26 and 27; and 23 CFR Parts 200, 230, and 633.

The following provision is adopted from 23 CFR 230, Appendix A, with appropriate revisions to conform to the U.S. Department of Labor (US DOL) and FHWA requirements.

**1. Equal Employment Opportunity:** Equal employment opportunity (EEO) requirements not to discriminate and to take affirmative action to assure equal opportunity as set forth under laws, executive orders, rules, regulations (28 CFR 35, 29 CFR 1630, 29 CFR 1625-1627, 41 CFR 60 and 49 CFR 27) and orders of the Secretary of Labor as modified by the provisions prescribed herein, and imposed pursuant to 23 U.S.C. 140 shall constitute the EEO and specific affirmative action standards for the contractor's project activities under

this contract. The provisions of the Americans with Disabilities Act of 1990 (42 U.S.C. 12101 et seq.) set forth under 28 CFR 35 and 29 CFR 1630 are incorporated by reference in this contract. In the execution of this contract, the contractor agrees to comply with the following minimum specific requirement activities of EEO:

a. The contractor will work with the contracting agency and the Federal Government to ensure that it has made every good faith effort to provide equal opportunity with respect to all of its terms and conditions of employment and in their review of activities under the contract.

b. The contractor will accept as its operating policy the following statement:

"It is the policy of this Company to assure that applicants are employed, and that employees are treated during employment, without regard to their race, religion, sex, color, national origin, age or disability. Such action shall include: employment, upgrading, demotion, or transfer; recruitment or recruitment advertising; layoff or termination; rates of pay or other forms of compensation; and selection for training, including apprenticeship, pre-apprenticeship, and/or on-the-job training."

**2. EEO Officer:** The contractor will designate and make known to the contracting officers an EEO Officer who will have the responsibility for and must be capable of effectively administering and promoting an active EEO program and who must be assigned adequate authority and responsibility to do so.

**3. Dissemination of Policy:** All members of the contractor's staff who are authorized to hire, supervise, promote, and discharge employees, or who recommend such action, or who are substantially involved in such action, will be made fully cognizant of, and will implement, the contractor's EEO policy and contractual responsibilities to provide EEO in each grade and classification of employment. To ensure that the above agreement will be met, the following actions will be taken as a minimum:

a. Periodic meetings of supervisory and personnel office employees will be conducted before the start of work and then not less often than once every six months, at which time the contractor's EEO policy and its implementation will be reviewed and explained. The meetings will be conducted by the EEO Officer.

b. All new supervisory or personnel office employees will be given a thorough indoctrination by the EEO Officer, covering all major aspects of the contractor's EEO obligations within thirty days following their reporting for duty with the contractor.

c. All personnel who are engaged in direct recruitment for the project will be instructed by the EEO Officer in the contractor's procedures for locating and hiring minorities and women.

d. Notices and posters setting forth the contractor's EEO policy will be placed in areas readily accessible to employees, applicants for employment and potential employees.

e. The contractor's EEO policy and the procedures to implement such policy will be brought to the attention of employees by means of meetings, employee handbooks, or other appropriate means.

**4. Recruitment:** When advertising for employees, the contractor will include in all advertisements for employees the notation: "An Equal Opportunity Employer." All such advertisements will be placed in publications having a large circulation among minorities and women in the area from which the project work force would normally be derived.

a. The contractor will, unless precluded by a valid bargaining agreement, conduct systematic and direct recruitment through public and private employee referral sources likely to yield qualified minorities and women. To meet this requirement, the contractor will identify sources of potential minority group employees, and establish with such identified sources procedures whereby minority and women applicants may be referred to the contractor for employment consideration.

b. In the event the contractor has a valid bargaining agreement providing for exclusive hiring hall referrals, the contractor is expected to observe the provisions of that agreement to the extent that the system meets the contractor's compliance with EEO contract provisions. Where implementation of such an agreement has the effect of discriminating against minorities or women, or obligates the contractor to do the same, such implementation violates Federal nondiscrimination provisions.

c. The contractor will encourage its present employees to refer minorities and women as applicants for employment. Information and procedures with regard to referring such applicants will be discussed with employees.

**5. Personnel Actions:** Wages, working conditions, and employee benefits shall be established and administered, and personnel actions of every type, including hiring, upgrading, promotion, transfer, demotion, layoff, and termination, shall be taken without regard to race, color, religion, sex, national origin, age or disability. The following procedures shall be followed:

a. The contractor will conduct periodic inspections of project sites to insure that working conditions and employee facilities do not indicate discriminatory treatment of project site personnel.

b. The contractor will periodically evaluate the spread of wages paid within each classification to determine any evidence of discriminatory wage practices.

c. The contractor will periodically review selected personnel actions in depth to determine whether there is evidence of discrimination. Where evidence is found, the contractor will promptly take corrective action. If the review indicates that the discrimination may extend beyond the actions reviewed, such corrective action shall include all affected persons.

d. The contractor will promptly investigate all complaints of alleged discrimination made to the contractor in connection with its obligations under this contract, will attempt to resolve such complaints, and will take appropriate corrective action within a reasonable time. If the investigation indicates that the discrimination may affect persons other than the complainant, such corrective action shall include such other persons. Upon completion of each investigation, the contractor will inform every complainant of all of their avenues of appeal.

**6. Training and Promotion:**

a. The contractor will assist in locating, qualifying, and increasing the skills of minorities and women who are

applicants for employment or current employees. Such efforts should be aimed at developing full journey level status employees in the type of trade or job classification involved.

b. Consistent with the contractor's work force requirements and as permissible under Federal and State regulations, the contractor shall make full use of training programs, i.e., apprenticeship, and on-the-job training programs for the geographical area of contract performance. In the event a special provision for training is provided under this contract, this subparagraph will be superseded as indicated in the special provision. The contracting agency may reserve training positions for persons who receive welfare assistance in accordance with 23 U.S.C. 140(a).

c. The contractor will advise employees and applicants for employment of available training programs and entrance requirements for each.

d. The contractor will periodically review the training and promotion potential of employees who are minorities and women and will encourage eligible employees to apply for such training and promotion.

**7. Unions:** If the contractor relies in whole or in part upon unions as a source of employees, the contractor will use good faith efforts to obtain the cooperation of such unions to increase opportunities for minorities and women. Actions by the contractor, either directly or through a contractor's association acting as agent, will include the procedures set forth below:

a. The contractor will use good faith efforts to develop, in cooperation with the unions, joint training programs aimed toward qualifying more minorities and women for membership in the unions and increasing the skills of minorities and women so that they may qualify for higher paying employment.

b. The contractor will use good faith efforts to incorporate an EEO clause into each union agreement to the end that such union will be contractually bound to refer applicants without regard to their race, color, religion, sex, national origin, age or disability.

c. The contractor is to obtain information as to the referral practices and policies of the labor union except that to the extent such information is within the exclusive possession of the labor union and such labor union refuses to furnish such information to the contractor, the contractor shall so certify to the contracting agency and shall set forth what efforts have been made to obtain such information.

d. In the event the union is unable to provide the contractor with a reasonable flow of referrals within the time limit set forth in the collective bargaining agreement, the contractor will, through independent recruitment efforts, fill the employment vacancies without regard to race, color, religion, sex, national origin, age or disability; making full efforts to obtain qualified and/or qualifiable minorities and women. The failure of a union to provide sufficient referrals (even though it is obligated to provide exclusive referrals under the terms of a collective bargaining agreement) does not relieve the contractor from the requirements of this paragraph. In the event the union referral practice prevents the contractor from meeting the obligations pursuant to Executive Order 11246, as amended, and these special provisions, such contractor shall immediately notify the contracting agency.

**8. Reasonable Accommodation for Applicants / Employees with Disabilities:** The contractor must be familiar

with the requirements for and comply with the Americans with Disabilities Act and all rules and regulations established there under. Employers must provide reasonable accommodation in all employment activities unless to do so would cause an undue hardship.

**9. Selection of Subcontractors, Procurement of Materials and Leasing of Equipment:** The contractor shall not discriminate on the grounds of race, color, religion, sex, national origin, age or disability in the selection and retention of subcontractors, including procurement of materials and leases of equipment. The contractor shall take all necessary and reasonable steps to ensure nondiscrimination in the administration of this contract.

a. The contractor shall notify all potential subcontractors and suppliers and lessors of their EEO obligations under this contract.

b. The contractor will use good faith efforts to ensure subcontractor compliance with their EEO obligations.

**10. Assurance Required by 49 CFR 26.13(b):**

a. The requirements of 49 CFR Part 26 and the State DOT's U.S. DOT-approved DBE program are incorporated by reference.

b. The contractor or subcontractor shall not discriminate on the basis of race, color, national origin, or sex in the performance of this contract. The contractor shall carry out applicable requirements of 49 CFR Part 26 in the award and administration of DOT-assisted contracts. Failure by the contractor to carry out these requirements is a material breach of this contract, which may result in the termination of this contract or such other remedy as the contracting agency deems appropriate.

**11. Records and Reports:** The contractor shall keep such records as necessary to document compliance with the EEO requirements. Such records shall be retained for a period of three years following the date of the final payment to the contractor for all contract work and shall be available at reasonable times and places for inspection by authorized representatives of the contracting agency and the FHWA.

a. The records kept by the contractor shall document the following:

(1) The number and work hours of minority and non-minority group members and women employed in each work classification on the project;

(2) The progress and efforts being made in cooperation with unions, when applicable, to increase employment opportunities for minorities and women; and

(3) The progress and efforts being made in locating, hiring, training, qualifying, and upgrading minorities and women;

b. The contractors and subcontractors will submit an annual report to the contracting agency each July for the duration of the project, indicating the number of minority, women, and non-minority group employees currently engaged in each work classification required by the contract work. This information is to be reported on [Form FHWA-1391](#). The staffing data should represent the project work force on board in all or any part of the last payroll period preceding the end of July. If on-the-job training is being required by special provision, the contractor

will be required to collect and report training data. The employment data should reflect the work force on board during all or any part of the last payroll period preceding the end of July.

### III. NONSEGREGATED FACILITIES

This provision is applicable to all Federal-aid construction contracts and to all related construction subcontracts of \$10,000 or more.

The contractor must ensure that facilities provided for employees are provided in such a manner that segregation on the basis of race, color, religion, sex, or national origin cannot result. The contractor may neither require such segregated use by written or oral policies nor tolerate such use by employee custom. The contractor's obligation extends further to ensure that its employees are not assigned to perform their services at any location, under the contractor's control, where the facilities are segregated. The term "facilities" includes waiting rooms, work areas, restaurants and other eating areas, time clocks, restrooms, washrooms, locker rooms, and other storage or dressing areas, parking lots, drinking fountains, recreation or entertainment areas, transportation, and housing provided for employees. The contractor shall provide separate or single-user restrooms and necessary dressing or sleeping areas to assure privacy between sexes.

### IV. DAVIS-BACON AND RELATED ACT PROVISIONS

This section is applicable to all Federal-aid construction projects exceeding \$2,000 and to all related subcontracts and lower-tier subcontracts (regardless of subcontract size). The requirements apply to all projects located within the right-of-way of a roadway that is functionally classified as Federal-aid highway. This excludes roadways functionally classified as local roads or rural minor collectors, which are exempt. Contracting agencies may elect to apply these requirements to other projects.

The following provisions are from the U.S. Department of Labor regulations in 29 CFR 5.5 "Contract provisions and related matters" with minor revisions to conform to the FHWA-1273 format and FHWA program requirements.

#### 1. Minimum wages

a. All laborers and mechanics employed or working upon the site of the work, will be paid unconditionally and not less often than once a week, and without subsequent deduction or rebate on any account (except such payroll deductions as are permitted by regulations issued by the Secretary of Labor under the Copeland Act (29 CFR part 3)), the full amount of wages and bona fide fringe benefits (or cash equivalents thereof) due at time of payment computed at rates not less than those contained in the wage determination of the Secretary of Labor which is attached hereto and made a part hereof, regardless of any contractual relationship which may be alleged to exist between the contractor and such laborers and mechanics.

Contributions made or costs reasonably anticipated for bona fide fringe benefits under section 1(b)(2) of the Davis-Bacon Act on behalf of laborers or mechanics are considered wages paid to such laborers or mechanics, subject to the provisions

of paragraph 1.d. of this section; also, regular contributions made or costs incurred for more than a weekly period (but not less often than quarterly) under plans, funds, or programs which cover the particular weekly period, are deemed to be constructively made or incurred during such weekly period. Such laborers and mechanics shall be paid the appropriate wage rate and fringe benefits on the wage determination for the classification of work actually performed, without regard to skill, except as provided in 29 CFR 5.5(a)(4). Laborers or mechanics performing work in more than one classification may be compensated at the rate specified for each classification for the time actually worked therein: Provided, That the employer's payroll records accurately set forth the time spent in each classification in which work is performed. The wage determination (including any additional classification and wage rates conformed under paragraph 1.b. of this section) and the Davis-Bacon poster (WH-1321) shall be posted at all times by the contractor and its subcontractors at the site of the work in a prominent and accessible place where it can be easily seen by the workers.

b. (1) The contracting officer shall require that any class of laborers or mechanics, including helpers, which is not listed in the wage determination and which is to be employed under the contract shall be classified in conformance with the wage determination. The contracting officer shall approve an additional classification and wage rate and fringe benefits therefore only when the following criteria have been met:

(i) The work to be performed by the classification requested is not performed by a classification in the wage determination; and

(ii) The classification is utilized in the area by the construction industry; and

(iii) The proposed wage rate, including any bona fide fringe benefits, bears a reasonable relationship to the wage rates contained in the wage determination.

(2) If the contractor and the laborers and mechanics to be employed in the classification (if known), or their representatives, and the contracting officer agree on the classification and wage rate (including the amount designated for fringe benefits where appropriate), a report of the action taken shall be sent by the contracting officer to the Administrator of the Wage and Hour Division, Employment Standards Administration, U.S. Department of Labor, Washington, DC 20210. The Administrator, or an authorized representative, will approve, modify, or disapprove every additional classification action within 30 days of receipt and so advise the contracting officer or will notify the contracting officer within the 30-day period that additional time is necessary.

(3) In the event the contractor, the laborers or mechanics to be employed in the classification or their representatives, and the contracting officer do not agree on the proposed classification and wage rate (including the amount designated for fringe benefits, where appropriate), the contracting officer shall refer the questions, including the views of all interested parties and the recommendation of the contracting officer, to the Wage and Hour Administrator for determination. The Wage and Hour Administrator, or an authorized representative, will issue a determination within 30 days of receipt and so advise the contracting officer or

will notify the contracting officer within the 30-day period that additional time is necessary.

(4) The wage rate (including fringe benefits where appropriate) determined pursuant to paragraphs 1.b.(2) or 1.b.(3) of this section, shall be paid to all workers performing work in the classification under this contract from the first day on which work is performed in the classification.

c. Whenever the minimum wage rate prescribed in the contract for a class of laborers or mechanics includes a fringe benefit which is not expressed as an hourly rate, the contractor shall either pay the benefit as stated in the wage determination or shall pay another bona fide fringe benefit or an hourly cash equivalent thereof.

d. If the contractor does not make payments to a trustee or other third person, the contractor may consider as part of the wages of any laborer or mechanic the amount of any costs reasonably anticipated in providing bona fide fringe benefits under a plan or program. Provided, That the Secretary of Labor has found, upon the written request of the contractor, that the applicable standards of the Davis-Bacon Act have been met. The Secretary of Labor may require the contractor to set aside in a separate account assets for the meeting of obligations under the plan or program.

## 2. Withholding

The contracting agency shall upon its own action or upon written request of an authorized representative of the Department of Labor, withhold or cause to be withheld from the contractor under this contract, or any other Federal contract with the same prime contractor, or any other federally-assisted contract subject to Davis-Bacon prevailing wage requirements, which is held by the same prime contractor, so much of the accrued payments or advances as may be considered necessary to pay laborers and mechanics, including apprentices, trainees, and helpers, employed by the contractor or any subcontractor the full amount of wages required by the contract. In the event of failure to pay any laborer or mechanic, including any apprentice, trainee, or helper, employed or working on the site of the work, all or part of the wages required by the contract, the contracting agency may, after written notice to the contractor, take such action as may be necessary to cause the suspension of any further payment, advance, or guarantee of funds until such violations have ceased.

## 3. Payrolls and basic records

a. Payrolls and basic records relating thereto shall be maintained by the contractor during the course of the work and preserved for a period of three years thereafter for all laborers and mechanics working at the site of the work. Such records shall contain the name, address, and social security number of each such worker, his or her correct classification, hourly rates of wages paid (including rates of contributions or costs anticipated for bona fide fringe benefits or cash equivalents thereof of the types described in section 1(b)(2)(B) of the Davis-Bacon Act), daily and weekly number of hours worked, deductions made and actual wages paid. Whenever the Secretary of Labor has found under 29 CFR 5.5(a)(1)(iv) that the wages of any laborer or mechanic include the amount of any costs reasonably anticipated in providing benefits under a plan or program described in section 1(b)(2)(B) of the Davis-

Bacon Act, the contractor shall maintain records which show that the commitment to provide such benefits is enforceable, that the plan or program is financially responsible, and that the plan or program has been communicated in writing to the laborers or mechanics affected, and records which show the costs anticipated or the actual cost incurred in providing such benefits. Contractors employing apprentices or trainees under approved programs shall maintain written evidence of the registration of apprenticeship programs and certification of trainee programs, the registration of the apprentices and trainees, and the ratios and wage rates prescribed in the applicable programs.

b.(1) The contractor shall submit weekly for each week in which any contract work is performed a copy of all payrolls to the contracting agency. The payrolls submitted shall set out accurately and completely all of the information required to be maintained under 29 CFR 5.5(a)(3)(i), except that full social security numbers and home addresses shall not be included on weekly transmittals. Instead the payrolls shall only need to include an individually identifying number for each employee (e.g., the last four digits of the employee's social security number). The required weekly payroll information may be submitted in any form desired. Optional Form WH-347 is available for this purpose from the Wage and Hour Division Web site at <http://www.dol.gov/esa/whd/forms/wh347instr.htm> or its successor site. The prime contractor is responsible for the submission of copies of payrolls by all subcontractors. Contractors and subcontractors shall maintain the full social security number and current address of each covered worker, and shall provide them upon request to the contracting agency for transmission to the State DOT, the FHWA or the Wage and Hour Division of the Department of Labor for purposes of an investigation or audit of compliance with prevailing wage requirements. It is not a violation of this section for a prime contractor to require a subcontractor to provide addresses and social security numbers to the prime contractor for its own records, without weekly submission to the contracting agency..

(2) Each payroll submitted shall be accompanied by a "Statement of Compliance," signed by the contractor or subcontractor or his or her agent who pays or supervises the payment of the persons employed under the contract and shall certify the following:

(i) That the payroll for the payroll period contains the information required to be provided under §5.5 (a)(3)(ii) of Regulations, 29 CFR part 5, the appropriate information is being maintained under §5.5 (a)(3)(i) of Regulations, 29 CFR part 5, and that such information is correct and complete;

(ii) That each laborer or mechanic (including each helper, apprentice, and trainee) employed on the contract during the payroll period has been paid the full weekly wages earned, without rebate, either directly or indirectly, and that no deductions have been made either directly or indirectly from the full wages earned, other than permissible deductions as set forth in Regulations, 29 CFR part 3;

(iii) That each laborer or mechanic has been paid not less than the applicable wage rates and fringe benefits or cash equivalents for the classification of work performed, as specified in the applicable wage determination incorporated into the contract.

(3) The weekly submission of a properly executed certification set forth on the reverse side of Optional Form WH-347 shall satisfy the requirement for submission of the "Statement of Compliance" required by paragraph 3.b.(2) of this section.

(4) The falsification of any of the above certifications may subject the contractor or subcontractor to civil or criminal prosecution under section 1001 of title 18 and section 231 of title 31 of the United States Code.

c. The contractor or subcontractor shall make the records required under paragraph 3.a. of this section available for inspection, copying, or transcription by authorized representatives of the contracting agency, the State DOT, the FHWA, or the Department of Labor, and shall permit such representatives to interview employees during working hours on the job. If the contractor or subcontractor fails to submit the required records or to make them available, the FHWA may, after written notice to the contractor, the contracting agency or the State DOT, take such action as may be necessary to cause the suspension of any further payment, advance, or guarantee of funds. Furthermore, failure to submit the required records upon request or to make such records available may be grounds for debarment action pursuant to 29 CFR 5.12.

#### 4. Apprentices and trainees

##### a. Apprentices (programs of the USDOL).

Apprentices will be permitted to work at less than the predetermined rate for the work they performed when they are employed pursuant to and individually registered in a bona fide apprenticeship program registered with the U.S. Department of Labor, Employment and Training Administration, Office of Apprenticeship Training, Employer and Labor Services, or with a State Apprenticeship Agency recognized by the Office, or if a person is employed in his or her first 90 days of probationary employment as an apprentice in such an apprenticeship program, who is not individually registered in the program, but who has been certified by the Office of Apprenticeship Training, Employer and Labor Services or a State Apprenticeship Agency (where appropriate) to be eligible for probationary employment as an apprentice.

The allowable ratio of apprentices to journeymen on the job site in any craft classification shall not be greater than the ratio permitted to the contractor as to the entire work force under the registered program. Any worker listed on a payroll at an apprentice wage rate, who is not registered or otherwise employed as stated above, shall be paid not less than the applicable wage rate on the wage determination for the classification of work actually performed. In addition, any apprentice performing work on the job site in excess of the ratio permitted under the registered program shall be paid not less than the applicable wage rate on the wage determination for the work actually performed. Where a contractor is performing construction on a project in a locality other than that in which its program is registered, the ratios and wage rates (expressed in percentages of the journeyman's hourly rate) specified in the contractor's or subcontractor's registered program shall be observed.

Every apprentice must be paid at not less than the rate specified in the registered program for the apprentice's level of progress, expressed as a percentage of the journeymen hourly

rate specified in the applicable wage determination. Apprentices shall be paid fringe benefits in accordance with the provisions of the apprenticeship program. If the apprenticeship program does not specify fringe benefits, apprentices must be paid the full amount of fringe benefits listed on the wage determination for the applicable classification. If the Administrator determines that a different practice prevails for the applicable apprentice classification, fringes shall be paid in accordance with that determination.

In the event the Office of Apprenticeship Training, Employer and Labor Services, or a State Apprenticeship Agency recognized by the Office, withdraws approval of an apprenticeship program, the contractor will no longer be permitted to utilize apprentices at less than the applicable predetermined rate for the work performed until an acceptable program is approved.

##### b. Trainees (programs of the USDOL).

Except as provided in 29 CFR 5.16, trainees will not be permitted to work at less than the predetermined rate for the work performed unless they are employed pursuant to and individually registered in a program which has received prior approval, evidenced by formal certification by the U.S. Department of Labor, Employment and Training Administration.

The ratio of trainees to journeymen on the job site shall not be greater than permitted under the plan approved by the Employment and Training Administration.

Every trainee must be paid at not less than the rate specified in the approved program for the trainee's level of progress, expressed as a percentage of the journeyman hourly rate specified in the applicable wage determination. Trainees shall be paid fringe benefits in accordance with the provisions of the trainee program. If the trainee program does not mention fringe benefits, trainees shall be paid the full amount of fringe benefits listed on the wage determination unless the Administrator of the Wage and Hour Division determines that there is an apprenticeship program associated with the corresponding journeyman wage rate on the wage determination which provides for less than full fringe benefits for apprentices. Any employee listed on the payroll at a trainee rate who is not registered and participating in a training plan approved by the Employment and Training Administration shall be paid not less than the applicable wage rate on the wage determination for the classification of work actually performed. In addition, any trainee performing work on the job site in excess of the ratio permitted under the registered program shall be paid not less than the applicable wage rate on the wage determination for the work actually performed.

In the event the Employment and Training Administration withdraws approval of a training program, the contractor will no longer be permitted to utilize trainees at less than the applicable predetermined rate for the work performed until an acceptable program is approved.

c. Equal employment opportunity. The utilization of apprentices, trainees and journeymen under this part shall be in conformity with the equal employment opportunity requirements of Executive Order 11246, as amended, and 29 CFR part 30.

d. Apprentices and Trainees (programs of the U.S. DOT).

Apprentices and trainees working under apprenticeship and skill training programs which have been certified by the Secretary of Transportation as promoting EEO in connection with Federal-aid highway construction programs are not subject to the requirements of paragraph 4 of this Section IV. The straight time hourly wage rates for apprentices and trainees under such programs will be established by the particular programs. The ratio of apprentices and trainees to journeymen shall not be greater than permitted by the terms of the particular program.

**5. Compliance with Copeland Act requirements.** The contractor shall comply with the requirements of 29 CFR part 3, which are incorporated by reference in this contract.

**6. Subcontracts.** The contractor or subcontractor shall insert Form FHWA-1273 in any subcontracts and also require the subcontractors to include Form FHWA-1273 in any lower tier subcontracts. The prime contractor shall be responsible for the compliance by any subcontractor or lower tier subcontractor with all the contract clauses in 29 CFR 5.5.

**7. Contract termination: debarment.** A breach of the contract clauses in 29 CFR 5.5 may be grounds for termination of the contract, and for debarment as a contractor and a subcontractor as provided in 29 CFR 5.12.

**8. Compliance with Davis-Bacon and Related Act requirements.** All rulings and interpretations of the Davis-Bacon and Related Acts contained in 29 CFR parts 1, 3, and 5 are herein incorporated by reference in this contract.

**9. Disputes concerning labor standards.** Disputes arising out of the labor standards provisions of this contract shall not be subject to the general disputes clause of this contract. Such disputes shall be resolved in accordance with the procedures of the Department of Labor set forth in 29 CFR parts 5, 6, and 7. Disputes within the meaning of this clause include disputes between the contractor (or any of its subcontractors) and the contracting agency, the U.S. Department of Labor, or the employees or their representatives.

**10. Certification of eligibility.**

a. By entering into this contract, the contractor certifies that neither it (nor he or she) nor any person or firm who has an interest in the contractor's firm is a person or firm ineligible to be awarded Government contracts by virtue of section 3(a) of the Davis-Bacon Act or 29 CFR 5.12(a)(1).

b. No part of this contract shall be subcontracted to any person or firm ineligible for award of a Government contract by virtue of section 3(a) of the Davis-Bacon Act or 29 CFR 5.12(a)(1).

c. The penalty for making false statements is prescribed in the U.S. Criminal Code, 18 U.S.C. 1001.

**V. CONTRACT WORK HOURS AND SAFETY STANDARDS ACT**

The following clauses apply to any Federal-aid construction contract in an amount in excess of \$100,000 and subject to the overtime provisions of the Contract Work Hours and Safety Standards Act. These clauses shall be inserted in addition to the clauses required by 29 CFR 5.5(a) or 29 CFR 4.6. As used in this paragraph, the terms laborers and mechanics include watchmen and guards.

**1. Overtime requirements.** No contractor or subcontractor contracting for any part of the contract work which may require or involve the employment of laborers or mechanics shall require or permit any such laborer or mechanic in any workweek in which he or she is employed on such work to work in excess of forty hours in such workweek unless such laborer or mechanic receives compensation at a rate not less than one and one-half times the basic rate of pay for all hours worked in excess of forty hours in such workweek.

**2. Violation; liability for unpaid wages; liquidated damages.** In the event of any violation of the clause set forth in paragraph (1.) of this section, the contractor and any subcontractor responsible therefor shall be liable for the unpaid wages. In addition, such contractor and subcontractor shall be liable to the United States (in the case of work done under contract for the District of Columbia or a territory, to such District or to such territory), for liquidated damages. Such liquidated damages shall be computed with respect to each individual laborer or mechanic, including watchmen and guards, employed in violation of the clause set forth in paragraph (1.) of this section, in the sum of \$10 for each calendar day on which such individual was required or permitted to work in excess of the standard workweek of forty hours without payment of the overtime wages required by the clause set forth in paragraph (1.) of this section.

**3. Withholding for unpaid wages and liquidated damages.** The FHWA or the contracting agency shall upon its own action or upon written request of an authorized representative of the Department of Labor withhold or cause to be withheld, from any moneys payable on account of work performed by the contractor or subcontractor under any such contract or any other Federal contract with the same prime contractor, or any other federally-assisted contract subject to the Contract Work Hours and Safety Standards Act, which is held by the same prime contractor, such sums as may be determined to be necessary to satisfy any liabilities of such contractor or subcontractor for unpaid wages and liquidated damages as provided in the clause set forth in paragraph (2.) of this section.

**4. Subcontracts.** The contractor or subcontractor shall insert in any subcontracts the clauses set forth in paragraph (1.) through (4.) of this section and also a clause requiring the subcontractors to include these clauses in any lower tier subcontracts. The prime contractor shall be responsible for compliance by any subcontractor or lower tier subcontractor with the clauses set forth in paragraphs (1.) through (4.) of this section.

## VI. SUBLETTING OR ASSIGNING THE CONTRACT

This provision is applicable to all Federal-aid construction contracts on the National Highway System.

1. The contractor shall perform with its own organization contract work amounting to not less than 30 percent (or a greater percentage if specified elsewhere in the contract) of the total original contract price, excluding any specialty items designated by the contracting agency. Specialty items may be performed by subcontract and the amount of any such specialty items performed may be deducted from the total original contract price before computing the amount of work required to be performed by the contractor's own organization (23 CFR 635.116).

a. The term "perform work with its own organization" refers to workers employed or leased by the prime contractor, and equipment owned or rented by the prime contractor, with or without operators. Such term does not include employees or equipment of a subcontractor or lower tier subcontractor, agents of the prime contractor, or any other assignees. The term may include payments for the costs of hiring leased employees from an employee leasing firm meeting all relevant Federal and State regulatory requirements. Leased employees may only be included in this term if the prime contractor meets all of the following conditions:

(1) the prime contractor maintains control over the supervision of the day-to-day activities of the leased employees;

(2) the prime contractor remains responsible for the quality of the work of the leased employees;

(3) the prime contractor retains all power to accept or exclude individual employees from work on the project; and

(4) the prime contractor remains ultimately responsible for the payment of predetermined minimum wages, the submission of payrolls, statements of compliance and all other Federal regulatory requirements.

b. "Specialty Items" shall be construed to be limited to work that requires highly specialized knowledge, abilities, or equipment not ordinarily available in the type of contracting organizations qualified and expected to bid or propose on the contract as a whole and in general are to be limited to minor components of the overall contract.

2. The contract amount upon which the requirements set forth in paragraph (1) of Section VI is computed includes the cost of material and manufactured products which are to be purchased or produced by the contractor under the contract provisions.

3. The contractor shall furnish (a) a competent superintendent or supervisor who is employed by the firm, has full authority to direct performance of the work in accordance with the contract requirements, and is in charge of all construction operations (regardless of who performs the work) and (b) such other of its own organizational resources (supervision, management, and engineering services) as the contracting officer determines is necessary to assure the performance of the contract.

4. No portion of the contract shall be sublet, assigned or otherwise disposed of except with the written consent of the contracting officer, or authorized representative, and such consent when given shall not be construed to relieve the contractor of any responsibility for the fulfillment of the contract. Written consent will be given only after the contracting agency has assured that each subcontract is

evidenced in writing and that it contains all pertinent provisions and requirements of the prime contract.

5. The 30% self-performance requirement of paragraph (1) is not applicable to design-build contracts; however, contracting agencies may establish their own self-performance requirements.

## VII. SAFETY: ACCIDENT PREVENTION

This provision is applicable to all Federal-aid construction contracts and to all related subcontracts.

1. In the performance of this contract the contractor shall comply with all applicable Federal, State, and local laws governing safety, health, and sanitation (23 CFR 635). The contractor shall provide all safeguards, safety devices and protective equipment and take any other needed actions as it determines, or as the contracting officer may determine, to be reasonably necessary to protect the life and health of employees on the job and the safety of the public and to protect property in connection with the performance of the work covered by the contract.

2. It is a condition of this contract, and shall be made a condition of each subcontract, which the contractor enters into pursuant to this contract, that the contractor and any subcontractor shall not permit any employee, in performance of the contract, to work in surroundings or under conditions which are unsanitary, hazardous or dangerous to his/her health or safety, as determined under construction safety and health standards (29 CFR 1926) promulgated by the Secretary of Labor, in accordance with Section 107 of the Contract Work Hours and Safety Standards Act (40 U.S.C. 3704).

3. Pursuant to 29 CFR 1926.3, it is a condition of this contract that the Secretary of Labor or authorized representative thereof, shall have right of entry to any site of contract performance to inspect or investigate the matter of compliance with the construction safety and health standards and to carry out the duties of the Secretary under Section 107 of the Contract Work Hours and Safety Standards Act (40 U.S.C.3704).

## VIII. FALSE STATEMENTS CONCERNING HIGHWAY PROJECTS

This provision is applicable to all Federal-aid construction contracts and to all related subcontracts.

In order to assure high quality and durable construction in conformity with approved plans and specifications and a high degree of reliability on statements and representations made by engineers, contractors, suppliers, and workers on Federal-aid highway projects, it is essential that all persons concerned with the project perform their functions as carefully, thoroughly, and honestly as possible. Willful falsification, distortion, or misrepresentation with respect to any facts related to the project is a violation of Federal law. To prevent any misunderstanding regarding the seriousness of these and similar acts, Form FHWA-1022 shall be posted on each Federal-aid highway project (23 CFR 635) in one or more places where it is readily available to all persons concerned with the project:

18 U.S.C. 1020 reads as follows:



"Whoever, being an officer, agent, or employee of the United States, or of any State or Territory, or whoever, whether a person, association, firm, or corporation, knowingly makes any false statement, false representation, or false report as to the character, quality, quantity, or cost of the material used or to be used, or the quantity or quality of the work performed or to be performed, or the cost thereof in connection with the submission of plans, maps, specifications, contracts, or costs of construction on any highway or related project submitted for approval to the Secretary of Transportation; or

Whoever knowingly makes any false statement, false representation, false report or false claim with respect to the character, quality, quantity, or cost of any work performed or to be performed, or materials furnished or to be furnished, in connection with the construction of any highway or related project approved by the Secretary of Transportation; or

Whoever knowingly makes any false statement or false representation as to material fact in any statement, certificate, or report submitted pursuant to provisions of the Federal-aid Roads Act approved July 1, 1916, (39 Stat. 355), as amended and supplemented;

Shall be fined under this title or imprisoned not more than 5 years or both."

#### **IX. IMPLEMENTATION OF CLEAN AIR ACT AND FEDERAL WATER POLLUTION CONTROL ACT**

This provision is applicable to all Federal-aid construction contracts and to all related subcontracts.

By submission of this bid/proposal or the execution of this contract, or subcontract, as appropriate, the bidder, proposer, Federal-aid construction contractor, or subcontractor, as appropriate, will be deemed to have stipulated as follows:

1. That any person who is or will be utilized in the performance of this contract is not prohibited from receiving an award due to a violation of Section 508 of the Clean Water Act or Section 306 of the Clean Air Act.

2. That the contractor agrees to include or cause to be included the requirements of paragraph (1) of this Section X in every subcontract, and further agrees to take such action as the contracting agency may direct as a means of enforcing such requirements.

#### **X. CERTIFICATION REGARDING DEBARMENT, SUSPENSION, INELIGIBILITY AND VOLUNTARY EXCLUSION**

This provision is applicable to all Federal-aid construction contracts, design-build contracts, subcontracts, lower-tier subcontracts, purchase orders, lease agreements, consultant contracts or any other covered transaction requiring FHWA approval or that is estimated to cost \$25,000 or more – as defined in 2 CFR Parts 180 and 1200.

##### **1. Instructions for Certification – First Tier Participants:**

a. By signing and submitting this proposal, the prospective first tier participant is providing the certification set out below.

b. The inability of a person to provide the certification set out below will not necessarily result in denial of participation in this

covered transaction. The prospective first tier participant shall submit an explanation of why it cannot provide the certification set out below. The certification or explanation will be considered in connection with the department or agency's determination whether to enter into this transaction. However, failure of the prospective first tier participant to furnish a certification or an explanation shall disqualify such a person from participation in this transaction.

c. The certification in this clause is a material representation of fact upon which reliance was placed when the contracting agency determined to enter into this transaction. If it is later determined that the prospective participant knowingly rendered an erroneous certification, in addition to other remedies available to the Federal Government, the contracting agency may terminate this transaction for cause of default.

d. The prospective first tier participant shall provide immediate written notice to the contracting agency to whom this proposal is submitted if any time the prospective first tier participant learns that its certification was erroneous when submitted or has become erroneous by reason of changed circumstances.

e. The terms "covered transaction," "debarred," "suspended," "ineligible," "participant," "person," "principal," and "voluntarily excluded," as used in this clause, are defined in 2 CFR Parts 180 and 1200. "First Tier Covered Transactions" refers to any covered transaction between a grantee or subgrantee of Federal funds and a participant (such as the prime or general contract). "Lower Tier Covered Transactions" refers to any covered transaction under a First Tier Covered Transaction (such as subcontracts). "First Tier Participant" refers to the participant who has entered into a covered transaction with a grantee or subgrantee of Federal funds (such as the prime or general contractor). "Lower Tier Participant" refers any participant who has entered into a covered transaction with a First Tier Participant or other Lower Tier Participants (such as subcontractors and suppliers).

f. The prospective first tier participant agrees by submitting this proposal that, should the proposed covered transaction be entered into, it shall not knowingly enter into any lower tier covered transaction with a person who is debarred, suspended, declared ineligible, or voluntarily excluded from participation in this covered transaction, unless authorized by the department or agency entering into this transaction.

g. The prospective first tier participant further agrees by submitting this proposal that it will include the clause titled "Certification Regarding Debarment, Suspension, Ineligibility and Voluntary Exclusion-Lower Tier Covered Transactions," provided by the department or contracting agency, entering into this covered transaction, without modification, in all lower tier covered transactions and in all solicitations for lower tier covered transactions exceeding the \$25,000 threshold.

h. A participant in a covered transaction may rely upon a certification of a prospective participant in a lower tier covered transaction that is not debarred, suspended, ineligible, or voluntarily excluded from the covered transaction, unless it knows that the certification is erroneous. A participant is responsible for ensuring that its principals are not suspended, debarred, or otherwise ineligible to participate in covered transactions. To verify the eligibility of its principals, as well as the eligibility of any lower tier prospective participants, each participant may, but is not required to, check the Excluded Parties List System website (<https://www.epls.gov/>), which is compiled by the General Services Administration.

i. Nothing contained in the foregoing shall be construed to require the establishment of a system of records in order to render in good faith the certification required by this clause. The knowledge and information of the prospective participant is not required to exceed that which is normally possessed by a prudent person in the ordinary course of business dealings.

j. Except for transactions authorized under paragraph (f) of these instructions, if a participant in a covered transaction knowingly enters into a lower tier covered transaction with a person who is suspended, debarred, ineligible, or voluntarily excluded from participation in this transaction, in addition to other remedies available to the Federal Government, the department or agency may terminate this transaction for cause or default.

\* \* \* \* \*

## **2. Certification Regarding Debarment, Suspension, Ineligibility and Voluntary Exclusion – First Tier Participants:**

a. The prospective first tier participant certifies to the best of its knowledge and belief, that it and its principals:

(1) Are not presently debarred, suspended, proposed for debarment, declared ineligible, or voluntarily excluded from participating in covered transactions by any Federal department or agency;

(2) Have not within a three-year period preceding this proposal been convicted of or had a civil judgment rendered against them for commission of fraud or a criminal offense in connection with obtaining, attempting to obtain, or performing a public (Federal, State or local) transaction or contract under a public transaction; violation of Federal or State antitrust statutes or commission of embezzlement, theft, forgery, bribery, falsification or destruction of records, making false statements, or receiving stolen property;

(3) Are not presently indicted for or otherwise criminally or civilly charged by a governmental entity (Federal, State or local) with commission of any of the offenses enumerated in paragraph (a)(2) of this certification; and

(4) Have not within a three-year period preceding this application/proposal had one or more public transactions (Federal, State or local) terminated for cause or default.

b. Where the prospective participant is unable to certify to any of the statements in this certification, such prospective participant shall attach an explanation to this proposal.

### **2. Instructions for Certification - Lower Tier Participants:**

(Applicable to all subcontracts, purchase orders and other lower tier transactions requiring prior FHWA approval or estimated to cost \$25,000 or more - 2 CFR Parts 180 and 1200)

a. By signing and submitting this proposal, the prospective lower tier is providing the certification set out below.

b. The certification in this clause is a material representation of fact upon which reliance was placed when this transaction was entered into. If it is later determined that the prospective lower tier participant knowingly rendered an erroneous certification, in addition to other remedies available to the Federal Government, the department, or agency with which

this transaction originated may pursue available remedies, including suspension and/or debarment.

c. The prospective lower tier participant shall provide immediate written notice to the person to which this proposal is submitted if at any time the prospective lower tier participant learns that its certification was erroneous by reason of changed circumstances.

d. The terms "covered transaction," "debarred," "suspended," "ineligible," "participant," "person," "principal," and "voluntarily excluded," as used in this clause, are defined in 2 CFR Parts 180 and 1200. You may contact the person to which this proposal is submitted for assistance in obtaining a copy of those regulations. "First Tier Covered Transactions" refers to any covered transaction between a grantee or subgrantee of Federal funds and a participant (such as the prime or general contract). "Lower Tier Covered Transactions" refers to any covered transaction under a First Tier Covered Transaction (such as subcontracts). "First Tier Participant" refers to the participant who has entered into a covered transaction with a grantee or subgrantee of Federal funds (such as the prime or general contractor). "Lower Tier Participant" refers any participant who has entered into a covered transaction with a First Tier Participant or other Lower Tier Participants (such as subcontractors and suppliers).

e. The prospective lower tier participant agrees by submitting this proposal that, should the proposed covered transaction be entered into, it shall not knowingly enter into any lower tier covered transaction with a person who is debarred, suspended, declared ineligible, or voluntarily excluded from participation in this covered transaction, unless authorized by the department or agency with which this transaction originated.

f. The prospective lower tier participant further agrees by submitting this proposal that it will include this clause titled "Certification Regarding Debarment, Suspension, Ineligibility and Voluntary Exclusion-Lower Tier Covered Transaction," without modification, in all lower tier covered transactions and in all solicitations for lower tier covered transactions exceeding the \$25,000 threshold.

g. A participant in a covered transaction may rely upon a certification of a prospective participant in a lower tier covered transaction that is not debarred, suspended, ineligible, or voluntarily excluded from the covered transaction, unless it knows that the certification is erroneous. A participant is responsible for ensuring that its principals are not suspended, debarred, or otherwise ineligible to participate in covered transactions. To verify the eligibility of its principals, as well as the eligibility of any lower tier prospective participants, each participant may, but is not required to, check the Excluded Parties List System website (<https://www.epls.gov/>), which is compiled by the General Services Administration.

h. Nothing contained in the foregoing shall be construed to require establishment of a system of records in order to render in good faith the certification required by this clause. The knowledge and information of participant is not required to exceed that which is normally possessed by a prudent person in the ordinary course of business dealings.

i. Except for transactions authorized under paragraph e of these instructions, if a participant in a covered transaction knowingly enters into a lower tier covered transaction with a person who is suspended, debarred, ineligible, or voluntarily excluded from participation in this transaction, in addition to other remedies available to the Federal Government, the

department or agency with which this transaction originated may pursue available remedies, including suspension and/or debarment.

\* \* \* \* \*

**Certification Regarding Debarment, Suspension, Ineligibility and Voluntary Exclusion--Lower Tier Participants:**

1. The prospective lower tier participant certifies, by submission of this proposal, that neither it nor its principals is presently debarred, suspended, proposed for debarment, declared ineligible, or voluntarily excluded from participating in covered transactions by any Federal department or agency.

2. Where the prospective lower tier participant is unable to certify to any of the statements in this certification, such prospective participant shall attach an explanation to this proposal.

\* \* \* \* \*

**XI. CERTIFICATION REGARDING USE OF CONTRACT FUNDS FOR LOBBYING**

This provision is applicable to all Federal-aid construction contracts and to all related subcontracts which exceed \$100,000 (49 CFR 20).

1. The prospective participant certifies, by signing and submitting this bid or proposal, to the best of his or her knowledge and belief, that:

a. No Federal appropriated funds have been paid or will be paid, by or on behalf of the undersigned, to any person for influencing or attempting to influence an officer or employee of any Federal agency, a Member of Congress, an officer or employee of Congress, or an employee of a Member of Congress in connection with the awarding of any Federal contract, the making of any Federal grant, the making of any Federal loan, the entering into of any cooperative agreement, and the extension, continuation, renewal, amendment, or modification of any Federal contract, grant, loan, or cooperative agreement.

b. If any funds other than Federal appropriated funds have been paid or will be paid to any person for influencing or attempting to influence an officer or employee of any Federal agency, a Member of Congress, an officer or employee of Congress, or an employee of a Member of Congress in connection with this Federal contract, grant, loan, or cooperative agreement, the undersigned shall complete and submit Standard Form-LLL, "Disclosure Form to Report Lobbying," in accordance with its instructions.

2. This certification is a material representation of fact upon which reliance was placed when this transaction was made or entered into. Submission of this certification is a prerequisite for making or entering into this transaction imposed by 31 U.S.C. 1352. Any person who fails to file the required certification shall be subject to a civil penalty of not less than \$10,000 and not more than \$100,000 for each such failure.

3. The prospective participant also agrees by submitting its bid or proposal that the participant shall require that the language of this certification be included in all lower tier subcontracts, which exceed \$100,000 and that all such recipients shall certify and disclose accordingly.

**ATTACHMENT A - EMPLOYMENT AND MATERIALS  
PREFERENCE FOR APPALACHIAN DEVELOPMENT  
HIGHWAY SYSTEM OR APPALACHIAN LOCAL ACCESS  
ROAD CONTRACTS**

This provision is applicable to all Federal-aid projects funded under the Appalachian Regional Development Act of 1965.

1. During the performance of this contract, the contractor undertaking to do work which is, or reasonably may be, done as on-site work, shall give preference to qualified persons who regularly reside in the labor area as designated by the DOL wherein the contract work is situated, or the subregion, or the Appalachian counties of the State wherein the contract work is situated, except:

a. To the extent that qualified persons regularly residing in the area are not available.

b. For the reasonable needs of the contractor to employ supervisory or specially experienced personnel necessary to assure an efficient execution of the contract work.

c. For the obligation of the contractor to offer employment to present or former employees as the result of a lawful collective bargaining contract, provided that the number of nonresident persons employed under this subparagraph (1c) shall not exceed 20 percent of the total number of employees employed by the contractor on the contract work, except as provided in subparagraph (4) below.

2. The contractor shall place a job order with the State Employment Service indicating (a) the classifications of the laborers, mechanics and other employees required to perform the contract work, (b) the number of employees required in each classification, (c) the date on which the participant estimates such employees will be required, and (d) any other pertinent information required by the State Employment Service to complete the job order form. The job order may be placed with the State Employment Service in writing or by telephone. If during the course of the contract work, the information submitted by the contractor in the original job order is substantially modified, the participant shall promptly notify the State Employment Service.

3. The contractor shall give full consideration to all qualified job applicants referred to him by the State Employment Service. The contractor is not required to grant employment to any job applicants who, in his opinion, are not qualified to perform the classification of work required.

4. If, within one week following the placing of a job order by the contractor with the State Employment Service, the State Employment Service is unable to refer any qualified job applicants to the contractor, or less than the number requested, the State Employment Service will forward a certificate to the contractor indicating the unavailability of applicants. Such certificate shall be made a part of the contractor's permanent project records. Upon receipt of this certificate, the contractor may employ persons who do not normally reside in the labor area to fill positions covered by the certificate, notwithstanding the provisions of subparagraph (1c) above.

5. The provisions of 23 CFR 633.207(e) allow the contracting agency to provide a contractual preference for the use of mineral resource materials native to the Appalachian region.

6. The contractor shall include the provisions of Sections 1 through 4 of this Attachment A in every subcontract for work which is, or reasonably may be, done as on-site work.